

VYNCO

20

24

BETTER PRODUCT
BETTER PLANET
BETTER LIVES

PRODUCT CATALOGUE

Prices correct as of 08 December 2023
and are subject to change.





Vynco Industries (NZ) Limited began in 1990, bringing innovative NZ designed, developed, and manufactured electrical products to the New Zealand market. 100% owned by the Vale family, Vynco today employs over 100 employees nationwide - with offices across Auckland, Christchurch and Wellington.

Focusing on research and development, Vynco's 15-strong Product Development team creates and develops products that challenge traditional ideas. Based in Christchurch, the Product Development team work with the brightest talent from New Zealand universities to develop local skill and provide opportunities to future engineers. Our in-house Quality & Compliance team ensures our products are checked and tested to a high standard and our product is supported throughout its lifetime.

The R&D logo throughout this book represents products that have been Researched & Developed by Vynco's in-house team.



R&DTM



Vynco's NZ-based manufacturing facilities offer a variety of customisation options. Utilising in-house manufacturing and local suppliers allows Vynco to accommodate changes in local regulations with efficiency and ease and gives us the ability to adapt and customise to meet the ever-evolving needs of the industry, the electrician and end-user. We are proudly part of the manufacturing community, keeping jobs within NZ.

Sustainability is a key value underpinning Vynco's operation and we strive to reduce the amount of waste created by the New Zealand construction and electrical markets. Through our introduction of moulded fibre product packaging, digitalisation, operational changes, local manufacturing and constant design improvements, Vynco is leading the industry in creating a more environmentally-friendly future.

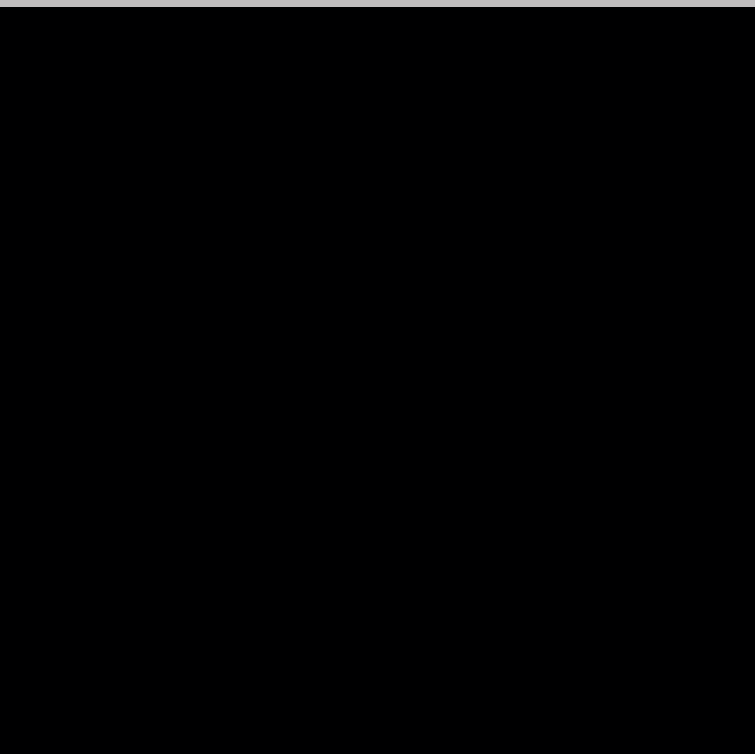

CONTENTS

SWITCHGEAR	URBAN Range	6
	METRO Range	14
	VILLAGE Range	18
	HOME Range	19
	Hot Water Isolator Kits	25
	Mechs	26
	Accessories	29
	Floorboxes	31

1

DISTRIBUTION BOXES	Electric Vehicle Chargers, Leads, & Accessories	84
	VM Series Boards & Accessories	90
	V Series Boards & Accessories	99
	Flush Distribution Boards	103
	Surface Distribution Boards	104
	Accessories	106
	Splitter Boards	107

4

INDUSTRIAL PLUGS & SOCKETS	Isolators & Switches	176
	Sockets	177
	Switches	179
	Plugs	180
	Connectors	182
	Enclosures	183
	Industrial Plugs & Sockets	184
	Plug & Socket Accessories	193
	Container Products	194
	NATO Plugs & Sockets	195
	Caravan and Marine Sockets & Connectors	196
	Caravan and Marine Leads & Plugs	198

LIGHTING

2

Architectural Lighting	40
Sensors	44
Steplights	45
Downlights	46
Surface Mounted Lights	51
Panels	54
Interior Battens	55
Underverandahs	57
Floodlights	58

AIR MOVEMENT

3

Interior Grilles	62
Exterior Grilles	67
Architectural Grille + Fan	71
Fans	72
Fan Kits	76
Ducts	80
Accessories	81

CIRCUIT PROTECTION

5

Residential/Commercial MCBs	110
Residential/Commercial RCBOs	111
Residential/Commercial RCCBs	113
Isolators	114
Commercial/Industrial MCBs	115
Commercial/Industrial RCBOs	122
Commercial/Industrial RCCBs	125
Arc Fault Detection Devices	127
CMS Devices & Accessories	129
Add-on Devices & Accessories	130
Changeover Switches	132
Surge Protection	133
Time Switches	134
Fuse Links	136
Lockout Kits & Accessories	140

ENCLOSURES

6

Polycarbonate Enclosures & Accessories	144
Polyester Enclosures & Accessories	148
Polyester Cabinets, Kits, & Accessories	151
Stainless Steel Cabinets	160
Outdoor Enclosure Accessories	162
Aluminium Cabinets	163
Polystyrene Enclosures & Accessories	164
HIBOX Enclosures & Accessories	167
Junction Boxes	172
Conduit Elbows & Bends	173

COMMERCIAL POWER

8

Onboard Switchboards	202
Chassis	210
Onboard Switchboard Accesories	211
Power Boards	217
Power Supply Units	218
Interconnecting Leads	221
Portable Lights	222

NOTES

9

IK/IP Rating Guide	224
Outdoor Suitable Enclosures	225
Notes	226



METRO SWITCHGEAR

NEW

Vynco Metro incorporates the homeowner's need for aesthetics and functionality, with a elegant slim, curved satin fascia.

Now available in black or white, Metro is compatible with all standard Vynco mechs, creating a versatile addition to your switchgear offering.

By offering a refreshed contemporary feel, this is a sophisticated step up from basic switchgear ranges.



Smooth Curves

Slim 6.5mm* profile

*The double horizontal with extra switch/USB has an 8.5mm profile.

SWITCHGEAR

URBAN Range	6
METRO Range	14
VILLAGE Range	18
HOME Range	19
Hot Water Isolator Kits	25
Mechs	26
Accessories	29
Floorboxes	31



URBAN SWITCHES - WHITE

250V AC

DESIGN
REGISTRATION
VYNCO Industries

Order Code	Description	Price excl. GST (each)	Material
USW1	One Gang 16A	\$27.67	PC
USW2	Two Gang 16A	\$46.65	Box Qty
USW3	Three Gang 16A	\$65.64	Box Qty: 10

URBAN COVER PLATES - WHITE

DESIGN
REGISTRATION
VYNCO Industries

Order Code	Description	Price excl. GST (each)	Material
USW1P	One Gang	\$24.37	PC
USW2P	Two Gang	\$24.37	Box Qty
USW3P	Three Gang	\$24.37	Box Qty: 10
USW4P	Four Gang	\$24.37	
USW5P	Five Gang	\$29.12	
USW6P	Six Gang	\$29.12	
USWBP	Blank Plate	\$23.27	



URBAN HORIZONTAL POWERPOINTS - WHITE

250V AC

Order Code	Description	Price excl. GST (each)	Material
UP1H	Single 10A	\$38.54	PC
UP2H	Double 10A	\$52.70	
UP2HX	Double 10A with Extra Switch*	\$86.48	Box Qty Box Qty: 8 Except UP1H / UP2H: 10
UP2HU2	Double 10A with USB C Power Module*	\$159.97	
UP2HUAC	Double 10A with USB A+C Power Module*	\$266.04	

* Profile depth is 8.4mm



URBAN VERTICAL POWERPOINTS - WHITE

250V AC

Order Code	Description	Price excl. GST (each)	Material
UP1V	Single 10A	\$38.54	PC
UP2V	Double 10A	\$55.34	
			Box Qty Box Qty: 10

URBAN SWITCHES - BLACK BLACK METAL

250V AC

DESIGN
REGISTRATION
VYNCO Industries

Order Code	Description	Price excl. GST (each)
USW1BBM	One Gang 16A	\$54.41
USW2BBM	Two Gang 16A	\$71.55
USW3BBM	Three Gang 16A	\$100.60

MaterialAnodised Aluminium
+
PC**Box Qty**

Box Qty: 10

URBAN COVER PLATES - BLACK BLACK METAL

DESIGN
REGISTRATION
VYNCO Industries

Order Code	Description	Price excl. GST (each)
USW1PBBM	One Gang	\$47.33
USW2PBBM	Two Gang	\$50.21
USW3PBBM	Three Gang	\$47.33
USW4PBBM	Four Gang	\$47.53
USW5PBBM	Five Gang	\$53.46
USW6PBBM	Six Gang	\$53.46
USWBPBBM	Blank Plate	\$44.28

MaterialAnodised Aluminium
+
PC**Box Qty**

Box Qty: 10

URBAN HORIZONTAL POWERPOINTS - BLACK BLACK METAL

250V AC



Order Code	Description	Price excl. GST (each)	Material
UP1HBBM	Single 10A	\$76.01	Anodised Aluminium + PC
UP2HBBM	Double 10A	\$84.55	
UP2HXBBM	Double 10A with Extra Switch*	\$111.18	Box Qty Box Qty: 8 Except UP1HBBM / UP2HBBM: 10
UP2HU2BBM	Double 10A with USB C Power Module*	\$217.53	
UP2HUACBBM	Double 10A with USB A+C Power Module*	\$295.02	

* Profile depth is 8.4mm

URBAN VERTICAL POWERPOINTS - BLACK BLACK METAL

250V AC



Order Code	Description	Price excl. GST (each)	Material
UP1VBBM	Single 10A	\$76.01	Anodised Aluminium + PC
UP2VBBM	Double 10A	\$84.55	
			Box Qty
			Box Qty: 10

URBAN SWITCHES - BLACK SILVER METAL

250V AC

DESIGN
REGISTRATION
VYNCO Industries

Order Code	Description	Price excl. GST (each)	Material
USW1BSM	One Gang 16A	\$54.41	Anodised Aluminium + PC
USW2BSM	Two Gang 16A	\$71.55	
USW3BSM	Three Gang 16A	\$100.60	

Box Qty

Box Qty: 10

URBAN COVER PLATES - BLACK SILVER METAL

DESIGN
REGISTRATION
VYNCO Industries

Order Code	Description	Price excl. GST (each)	Material
USW4PBSM	Four Gang	\$47.33	Anodised Aluminium + PC
USW5PBSM	Five Gang	\$53.46	
USW6PBSM	Six Gang	\$53.46	
USWBPBSM	Blank Plate	\$44.28	

Box Qty

Box Qty: 10

URBAN HORIZONTAL POWERPOINTS - BLACK SILVER METAL

250V AC



Order Code	Description	Price excl. GST (each)
UP1HBSM	Single 10A	Coming soon
UP2HBSM	Double 10A	\$84.55
UP2HXBSM	Double 10A with Extra Switch*	\$111.18
UP2HUACBSM	Double 10A with USB A+C Power Module*	\$295.02

* Profile depth is 8.4mm

Material
Anodised Aluminium + PC
Box Qty
Box Qty: 8 Except UP1HBSM / UP2HBSM: 10

URBAN VERTICAL POWERPOINTS - BLACK SILVER METAL

250V AC



Order Code	Description	Price excl. GST (each)
UP2VBSM	Double 10A	\$84.55

Material
Anodised Aluminium + PC
Box Qty
Box Qty: 10

URBAN SWITCHES - WHITE SILVER METAL

250V AC

DESIGN
REGISTRATION
VYNCO Industries

Order Code	Description	Price excl. GST (each)
USW1WSM	One Gang 16A	\$54.41
USW2WSM	Two Gang 16A	\$71.55
USW3WSM	Three Gang 16A	\$100.60

MaterialAnodised Aluminium
+
PC**Box Qty**

Box Qty: 10

URBAN COVER PLATES - WHITE SILVER METAL

DESIGN
REGISTRATION
VYNCO Industries

Order Code	Description	Price excl. GST (each)
USW4PWSM	Four Gang	\$47.33
USW5PWSM	Five Gang	\$53.46
USW6PWSM	Six Gang	\$53.46
USWBPWSM	Blank Plate	\$44.28

MaterialAnodised Aluminium
+
PC**Box Qty**

Box Qty: 10



URBAN HORIZONTAL POWERPOINTS - WHITE SILVER METAL

250V AC



Order Code	Description	Price excl. GST (each)
UP1HWSM	Single 10A	Coming soon
UP2HWSM	Double 10A	\$84.55
UP2HXWSM	Double 10A with Extra Switch*	\$111.18
UP2HUACWSM	Double 10A with USB A+C Power Module*	\$295.02

* Profile depth is 8.4mm

Material
Anodised Aluminium + PC
Box Qty
Box Qty: 8 Except UP1HWSM / UP2HWSM: 10

URBAN VERTICAL POWERPOINTS - WHITE SILVER METAL

250V AC



Order Code	Description	Price excl. GST (each)
UP2VWSM	Double 10A	\$84.55

Material
Anodised Aluminium + PC
Box Qty
Box Qty: 10

METRO SWITCHES - WHITE

250V AC

NEW



Order Code	Description	Price excl. GST (each)	Material
MSW1	One Gang 16A	\$17.63	PC
MSW2	Two Gang 16A	\$27.68	Box Qty
MSW3	Three Gang 16A	\$40.58	Box Qty: 10

METRO COVER PLATES - WHITE



Order Code	Description	Price excl. GST (each)	Material
MSW1P	One Gang	\$13.69	PC
MSW2P	Two Gang	\$13.83	Box Qty
MSW3P	Three Gang	\$13.94	Box Qty: 10
MSW4P	Four Gang	\$14.28	
MSW5P	Five Gang	\$16.89	
MSW6P	Six Gang	\$17.04	
MSWBP	Blank Plate	\$14.83	

METRO HORIZONTAL POWERPOINTS - WHITE

250V AC



Order Code	Description	Price excl. GST (each)	Material
MP1H	Single 10A	\$23.12	PC
MP2H	Double 10A	\$32.94	
MP2HX	Double 10A with Extra Switch*	\$54.19	Box Qty
MP2HU2	Double 10A with double USB C Power Module*	\$147.11	Box Qty: 8
MP2HUAC	Double 10A with USB A+C Power Module*	\$205.95	Except MP1H/MP2H: 10

* Profile depth is 8.4mm

METRO VERTICAL POWERPOINTS - WHITE

250V AC



Order Code	Description	Price excl. GST (each)	Material
MP1V	Single 10A	\$23.12	PC
MP2V	Double 10A	\$32.94	Box Qty
			Box Qty: 10

METRO SWITCHES - BLACK

250V AC

NEW



VYNCO Industries



Order Code	Description	Price excl. GST (each)	Material
MSW1B	One Gang 16A	\$21.16	PC
MSW2B	Two Gang 16A	\$33.22	Box Qty
MSW3B	Three Gang 16A	\$48.70	Box Qty: 10

METRO COVER PLATES - BLACK



VYNCO Industries



Order Code	Description	Price excl. GST (each)	Material
MSW1PB	One Gang	\$16.43	PC
MSW2PB	Two Gang	\$16.60	Box Qty
MSW3PB	Three Gang	\$16.73	Box Qty: 10
MSW4PB	Four Gang	\$17.13	
MSW5PB	Five Gang	\$20.28	
MSW6PB	Six Gang	\$20.44	
MSWBPB	Blank Plate	\$17.80	

METRO HORIZONTAL POWERPOINTS - BLACK

250V AC



Order Code	Description	Price excl. GST (each)	Material
MP1HB	Single 10A	\$27.74	PC
MP2HB	Double 10A	\$39.53	Box Qty Box Qty: 8 Except MP1HB / MP2HB: 10
MP2HXB	Double 10A with Extra Switch*	\$65.03	
MP2HU2B	Double 10A with Double USB C Power Module*	\$176.53	
MP2HUACB	Double 10A with Double USB A+C Power Module*	\$205.95	

* Profile depth is 8.4mm

METRO VERTICAL POWERPOINTS - BLACK

250V AC



Order Code	Description	Price excl. GST (each)	Material
MP1VB	Single 10A	\$27.74	PC
MP2VB	Double 10A	\$39.53	Box Qty Box Qty: 10

VILLAGE SWITCHES - WHITE

250V AC

Bronze.

NEW

DESIGN
REGISTRATION
VYNCO IndustriesBest Design Awards
Winner 2023

Order Code	Description	Price excl. GST (each)	Material
VSW1H	One Gang 16A	\$31.00	PC
VSW2H	Two Gang 16A	\$40.00	Box Qty
VSW3H	Three Gang 16A	\$45.00	Box Qty: 10

VILLAGE COVER PLATES - WHITE

DESIGN
REGISTRATION
VYNCO Industries

Order Code	Description	Price excl. GST (each)	Material
VSW1HP	One Gang	\$19.00	PC
VSW2HP	Two Gang	\$19.00	Box Qty
VSW3HP	Three Gang	\$19.00	Box Qty: 10

VILLAGE MECHS

DESIGN
REGISTRATION
VYNCO Industries

Order Code	Description	Box Qty	Price excl. GST (each)
88MLPBM10	Village Large Push Button Momentary 10A	10	\$38.56
88MLUAD	Village Large Universal Adaptor	10	\$2.75
88SML110	Village Large Mech 10A Intermediate	10	\$19.00
88SML16	Village Large Mech 16A	10	\$11.75
88SML32	Village Large Mech 32A	10	\$16.25



HOME SWITCHES - WHITE



Order Code	Description	Price excl. GST (each)
2S1	One Gang 16A	\$15.07
2S1/32	One Gang 32A	\$33.41
2S2	Two Gang 16A	\$21.08
2S3	Three Gang 16A	\$33.11

Material
PC
Box Qty
Box Qty: 10

HOME COVER PLATES - WHITE



Order Code	Description	Price excl. GST (each)
2S1P	One Gang	\$10.28
2S2P	Two Gang	\$10.57
2S3P	Three Gang	\$10.80
2S4P	Four Gang	\$11.51
2S5P	Five Gang	\$12.38
2S6P	Six Gang	\$12.68
2SBP	Blank Plate	\$12.68

Material
PC
Box Qty
Box Qty: 10

HOME SPECIALTY SWITCHES - WHITE

250V AC



Order Code	Description	Price excl. GST (each)	Material
2PC1	Permanent Connection 16A	\$25.87	PC
2S1IP	One Gang 16A, IP56	\$26.16	Box Qty
2S2IP	Two Gang 16A, IP56	\$35.97	Box Qty: 10

HOME CARD SWITCH - WHITE

250V AC



Order Code	Description	Price excl. GST (each)	Material
2CS1W	Card Switch 16A	\$268.70	PC
			Box Qty
			Box Qty: 8

HOME HORIZONTAL POWERPOINTS - WHITE

250V AC



Order Code	Description	Price excl. GST (each)
2P1H	Single 10A	\$19.22
2P1H15	Single 15A	\$29.50
2P2H	Double 10A	\$25.24
2P2H15	Double 15A	\$57.19
2P2HX	Double 10A with Extra Switch	\$45.16
2P2HU2	Double 10A with Double USB	\$139.36
2P4H	Four Gang 10A	\$73.66

Material
PC
Box Qty
Box Qty: 10 Except 2P2HU2: 8 2P4H: 5

HOME VERTICAL POWERPOINTS - WHITE

250V AC



Order Code	Description	Price excl. GST (each)
2P1V	Single 10A	\$19.22
2P1V15	Single 15A	\$29.50
2P2V	Double 10A	\$25.24
2P2V15	Double 15A	\$57.19
2P2VX	Double 10A with Extra Switch	\$45.16
2P2VU2	Double 10A with Double USB C	\$139.36

Material
PC
Box Qty
Box Qty: 10 Except 2P2VU2/: 8

HOME SWITCHES - BLACK

250V AC



Order Code	Description	Price excl. GST (each)	Material
2S1B	One Gang 16A	\$16.07	PC
2S2B	Two Gang 16A	\$22.48	Box Qty
2S3B	Three Gang 16A	\$35.34	Box Qty: 10

HOME COVER PLATES - BLACK



Order Code	Description	Price excl. GST (each)	Material
2S1PB	One Gang	\$10.92	PC
2S2PB	Two Gang	\$11.25	Box Qty
2S3PB	Three Gang	\$11.51	Box Qty: 10
2S4PB	Four Gang	\$12.27	
2S5PB	Five Gang	\$13.20	
2S6PB	Six Gang	\$13.49	
2SBPB	Blank Plate	\$13.49	

HOME PERMANENT CONNECTION - BLACK

250V AC



Order Code	Description	Price excl. GST (each)	Material
2PC1B	Permanent Connection 16A	\$27.62	PC
			Box Qty
			Box Qty: 10

HOME CARD SWITCH - BLACK

250V AC



Order Code	Description	Price excl. GST (each)	Material
2CS1B	Card Switch 16A	\$268.70	PC
			Box Qty
			Box Qty: 8

HOME HORIZONTAL POWERPOINTS - BLACK

250V AC



Order Code	Description	Price excl. GST (each)	Material
2P1HB	Single 10A	\$20.51	PC
2P1H15B	Single 15A	\$31.49	
2P2HB	Double 10A	\$26.92	PC
2P2H15B	Double 15A	\$61.04	
2P2HXB	Double 10A with Extra Switch	\$48.19	PC
2P2HU2B	Double 10A with Double USB	\$147.76	

Box Qty

Box Qty: 10
Except 2P2HXB / 2P2HU2B: 8

HOME VERTICAL POWERPOINTS - BLACK

250V AC



Order Code	Description	Price excl. GST (each)	Material
2P1VB	Single 10A	\$20.51	PC
2P1V15B	Single 15A	\$31.49	
2P2VB	Double 10A	\$26.92	PC
2P2V15B	Double 15A	\$61.04	
2P2VXB	Double 10A with Extra Switch	\$48.19	PC
2P2VU2B	Double 10A with Double USB	\$147.76	

Box Qty

Box Qty: 10
Except 2P2VU2B / 2P2VUACB: 8

HOT WATER ISOLATOR KITS

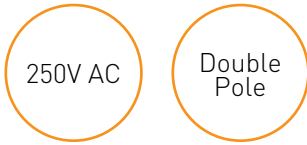

Order Code	Description	Price excl. GST	Material
88HWSK1	Hot Water Switch Kit	\$117.90	PC
HWIKA*	Hot Water Isolator Kit, Angled, 20A – Lockable	\$121.28	

Carton Qty
Box Qty: 1

*Complies with AS/NZS 3000:2018 as a Hot Water Isolator

FEATURES

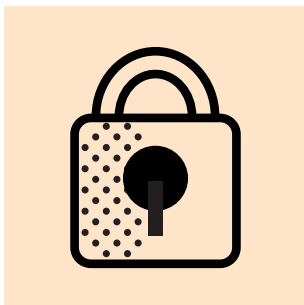

Lockable**
HWIKA only

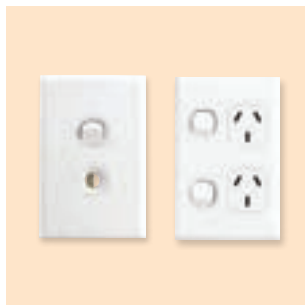

Matches Home switchgear
range aesthetic



Kits come prewired and
terminated, ready for
immediate fitting

SWITCH MECHS

250V AC



Description	Box Qty	White Order Code	Price excl. GST	Black Order Code	Price excl. GST
16A	10	88SM16	\$14.08ea	88SM16B	\$15.49ea
32A	10	88SM32	\$21.60ea	88SM32B	\$23.01ea
Intermediate 10A	10	88SMI10	\$66.72ea	88SMI10B	\$68.13ea
Double Pole 20A	10	88SMD20	\$31.88ea	N/A	N/A



PUSH BUTTON, SENSING, AND ROTARY MECHS

220 to
250V AC

Description	Box Qty	White Order Code	Price excl. GST	Black Order Code	Price excl. GST
Push Button Momentary 2A	10	88SMP2	\$15.04ea	88SMP2B	\$16.45ea
Push Button Momentary 10A	10	88MPBM10	\$36.36ea	88MPBM10B	\$38.89ea
Push Button Latching 16A	10	88PBM16	\$36.36ea	88PBM16B	\$38.89ea
Push Button Timer Mech, 1000W, 30Sec-4Hrs	10	88PBT1	\$121.06ea	88PBT1B	\$157.75ea
Motion Sensor Mech, 800W, Adj. Time and Lux	10	88PIRM	\$161.91ea	88PIRMB	\$184.04ea
Rotary 10A	10	88SMR4	\$21.21ea	88SMR4B	\$23.33ea
Rotary Switch, Auto/ Off / Manual	10	88SMR4AM	\$23.08ea	88SMR4AMB	\$22.66ea
Rotary Dimmer 300W	20	88DR	\$101.65	88DRB	\$113.42
Push Button Rotary Dimmer	20	88DRP	\$163.71	88DRPB	\$181.90
Push Button Dimmer	20	88DP	\$174.41	88DPB	\$192.60
Push Button- Momentary Signal Switch	20	88SPM	\$73.30	88SPMB	\$73.30





DEDICATED SWITCH MECHS

250V AC

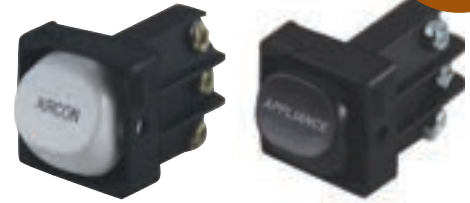

Description	Box Qty	White Order Code	Price excl. GST	Black Order Code	Price excl. GST
"Aircon" 16A	10	88SM16AC	\$15.04ea	N/A	N/A
"Appliance" 16A	10	88SM16AP	\$15.04ea	88SM16APB	\$16.45ea
"Auto/Manual" 16A	10	88SM16AM	\$15.04ea	N/A	N/A
"Dishwasher" 16A	10	88SM16DW	\$15.42ea	88SM16DWB	\$16.45ea
"Dryer" 16A	10	88SM16DY	\$15.04ea	N/A	N/A
"Fan" 16A	10	88SM16F	\$15.04ea	88SM16FB	\$16.45ea
"Fridge" 16A	10	88SM16FG	\$15.04ea	88SM16FGB	\$16.45ea
"Heat" 16A	10	88SM16H	\$15.04ea	88SM16HB	\$16.45ea
"Heater" 32A	10	88SM32HR	\$24.87ea	N/A	N/A
"Hob" 32A	10	88SM32HB	\$24.87ea	88SM32HBB	\$27.38ea
"Heated Towel Rail" 16A	10	88SM16HTR	\$15.04ea	N/A	N/A
"Hood" 16A	10	88SM16HD	\$15.04ea	88SM16HDB	\$16.45ea
"Kitchen" 16A	10	88SM16KT	\$15.04ea	N/A	N/A
"Light" 16A	10	88SM16L	\$15.04ea	88SM16LB	\$16.45ea
"Microwave" 16A	10	88SM16MW	\$15.04ea	88SM16MWB	\$16.45ea
"Mirror" 16A	10	88SM16M	\$15.04ea	88SM16MB	\$16.45ea
"On/Off" 16A	10	88SM16I/O	\$15.04ea	N/A	N/A
"Outside" 16A	10	88SM16OS	\$15.04ea	88SM16OSB	\$16.45ea
"Oven" 32A	10	88SM32OV	\$24.87ea	88SM32OVb	\$27.38ea
"Pump" 16A	10	88SM16PU	\$15.04ea	N/A	N/A
"Range" 32A	10	88SM32R	\$24.87ea	88SM32RB	\$27.38ea
"Sensor" 16A	10	88SM16SE	\$15.04ea	88SM16SEB	\$16.45ea
"Spa" 16A	10	88SM16S	\$15.04ea	N/A	N/A
"Wash" 16A	10	88SM16W	\$15.04ea	88SM16WB	\$16.45ea
"Waste" 16A	10	88SM16WT	\$15.04ea	88SM16WTB	\$16.46ea

Custom printed mechs available on request.

SPECIALITY MECHS

250V AC



Description	Box Qty	Order Code	Price excl. GST
Neon Red	10	88NMR	\$38.24ea
Neon Green	10	88NMG	\$38.24ea
Rotary Fan Switch, 4 Positions	10	88M4F	\$22.63ea
Fan Controller Switch, 3 Speed	5	88FC3	\$36.76ea



USB POWER MECHS

220 to
250V AC

Description	Box Qty	White Order Code	Price excl. GST	Black Order Code	Price excl. GST
USB A + C Power Adaptor Mech	10	88USBMAC	\$151.20	88USMACB	\$151.20
USB 2 x A Power Adaptor Mech	10	88USBM2	\$100.80	88USBM2B	\$96.00





DATA AND COMMUNICATIONS MECHS

Description	Box Qty	White Order Code	Price excl. GST	Black Order Code	Price excl. GST
Permanent Connection	10	88PCM	\$11.31ea	88PCMB	\$12.47ea
Keystone Clip For use with keystone RJ-45 mechs	20	88KST	\$4.50ea	88KSTB	\$4.50ea
TV Coaxial 75 ohm	10	88TVM	\$16.52ea	88TVMB	\$18.12ea
TV F Type 75 ohm	10	88TVFM	\$9.90ea	88TVFMB	\$10.93ea
TV F to Coaxial 75 ohm	10	88TVFCM	\$12.92ea	88TVFCMB	\$14.21ea
Blank Mech	20	88SMB	\$1.80ea	88SMBB	\$2.00ea
Data Socket Cat6/RJ45	10	88DM6	\$17.87ea	88DM6B	\$19.60ea
Data Socket Cat5E/RJ45	10	88DM5E	\$21.49ea	N/A	N/A
USB Adaptor Lead	1	88USB	\$75.18ea	N/A	N/A
HDMI Adaptor Lead	1	88HDMI	\$80.64ea	N/A	N/A



ACCESSORIES

Description	Box Qty	White Order Code	Price excl. GST	Black Order Code	Price excl. GST
Deep Mounting Block, White 37mm Deep	10	88MB37	\$9.24ea	88MB37B	\$10.25ea
Standard Mounting Block, White 30mm Deep	10	88MB30	\$9.80ea	88MB30B	\$10.25ea
Panel Mount Clip To fit sheet-metal thicknesses of 0.8mm to 1.2mm	20	88PMC	\$4.37ea	88PMCB	\$4.37ea





ACCESSORIES

Order Code	Description	Box Qty	Price excl. GST	
88MB18	Shallow Mounting Block White, 18mm Deep	10	\$9.80ea	
88MBDI	Double Insulated Mounting Block	5	\$14.73ea	
VFBP	Flush Box Plastic Thread	100	\$2.95ea	
VFBM	Flush Box Metal Thread	100	\$2.95ea	
MBD	Metro Mounting Block White, 37mm Deep	10	\$9.68ea	
88GP12*	12 Gang Grid Panel 200mm x 160mm x 70mm	1	\$437.66ea	
88GP20*	20 Gang Grid Panel 240mm x 200mm x 70mm	1	\$556.45ea	
88GP30*	30 Gang Grid Panel 280mm x 240mm x 70mm	1	\$700.26ea	
88JB	Standard Junction Box 32A	10	\$17.29ea	
88JBL	Large Junction Box 40A	10	\$18.63ea	
88T1J100	40A Connectors Single Screw, Jar of 100	1	\$117.13ea	
88T2J	40A Connectors Twin Screw, Jar of 50	1	\$117.13ea	
88BH	Standard Batten Holder 150W	10	\$14.22ea	
88LH	Unswitched Lamp Holder	10	\$15.96ea	
88CR	Ceiling Rose 5A, 4 Terminal	10	\$20.63ea	
88SS1	Single Surface Socket	10	\$15.91ea	
88SS2	Double Surface Socket	10	\$25.75ea	

*Supplied with Steel Mounting Box and Panel Mount Clips

FLOORBOXES - ROUND

Compact Design

Versatile and practical options





Order Code		Power	Data	Box Size (HxWxD)	Lid Size (HxWxD)	Rebate	Lid Position	Lid Finish	Price excl. GST.
FB130		1 x Auto Switch Socket Outlet	N/A	Ø 95 x 50mm	Ø 130mm	N/A	Surface	Stainless	\$577.50
FB175		1 x Standard Double Socket Outlet	3 x Modular Data Mounts	125 x 125 x 110mm	Ø 175mm	N/A	Surface	Stainless	\$808.50
FB5SF		2 x Standard Double Socket Outlets	2x Standard Double Data Plates	Ø 298mm x 110mm	Ø 325mm	N/A	Surface	Stainless	\$1218.00
FB5SR		2 x Standard Double Socket Outlets	2x Standard Double Data Plates	Ø 298mm x 110mm	Ø 325mm	6mm Rebated	Surface	Stainless	\$1218.00
FBIP2P2DNC		2 x Auto Switched Sockets	2 x Modular Data Mounts	Ø 132mm x 100mm	Ø 150mm	N/A	Surface	Nickel	\$1155.00

FLOORBOXES - ROUND LID ONLY

Order Code		Power	Data	Box Size (HxWxD)	Lid Size (HxWxD)	Rebate	Lid Position	Lid Finish	Price excl. GST.
FB130-LF		1 x Auto Switch Socket Outlet	N/A	N/A	Ø 130mm	N/A	Surface	Stainless	\$320.25

FLOORBOXES - ABOVE GROUND

Steel
ConstructionSleek
DesignSimple
Installation

Order Code		Power	Data	Lid Size (HxWxD)	Finish	Price excl. GST.
AFB20SS		1 x Standard Double Socket Outlet	1 x Standard Double Data Plate	110 x125 x 140mm	Stainless	\$210.00
AFB202SS		2 x Standard Double Socket Outlet	2 x Standard Double Data Plate	110 x250 x 140mm	Stainless	\$315.00
AFB3510A2DBK		1 x Auto Switched Socket Outlet	2 x Modular Data Mounts	50 x160 x 127mm	Powder Coated Black	POA
AFB70SS		1 x Double Socket Outlet	4 x Modular Data Mounts	65 x175 x 140mm	Stainless	\$420.00

FLOORBOXES - POP UP

Satin Alloy
Lid Finish

Lid
Damper

Compact
Design

Order Code		Power	Data	Box Size (HxWxD)	Lid Size (HxWxD)	Price excl. GST.
FB110		1 x Auto Switched Socket Outlet	N/A	101 x101 x 63mm	120 x 118mm	\$221.55
FB111		N/A	2 x USB A	101 x101 x 63mm	120 x 118mm	POA
FB112		N/A	1 x USB A 1 x USB C	101 x101 x 63mm	120 x 118mm	POA
FB120		2 x Auto Switched Socket Outlets	N/A	120 x120 x 63mm	155 x 145mm	\$409.50
FB121		N/A	2 x Modular Data Mounts	120 x120 x 63mm	155 x 145mm	\$346.50
FB124		1 x Auto Switched Socket Outlet	2 x USB A	120 x120 x 63mm	155 x 145mm	POA
FB125		1 x Auto Switched Socket Outlet	1 x USB A 1 x USB C	120 x120 x 63mm	155 x 145mm	POA

FLOORBOXES - FLUSH AND SURFACE







Robust
DesignCable
Shield
Options

Order Code		Power	Data	Box Size (HxWxD)	Lid Size (HxWxD)	Rebate	Lid Position	Lid Finish	Price excl. GST.
FB147		1 x Standard Double Socket Outlet	1 x 3-Gang Architrave Data Plate	135 x 126 x 95mm	145 x 145mm	N/A	Surface	Brass	\$645.75
FB149		1 x Standard Double Socket Outlet	3 x Modular Data Mounts	135 x 126 x 120mm	150x 150 x 25mm	20mm Rebated	Flush	Stainless	\$777.00
FB4SHD		2 x Standard Double Socket Outlets	2 x Standard Double Data Plates	240 x 240 x 120mm	275x 275 x 25mm	N/A	Flush	Stainless Heavy Duty	\$1596.00
FB4SQF		2 x Standard Double Socket Outlets	2 x Standard Double Data Plates	240x 240 x 110mm	266x 266 mm	N/A	Flush	Stainless	\$997.50
FB2SDR70		2 x Auto Switched Socket Outlets	3 x Modular Data Mounts	240x 150 x 93mm	250x 160 x 38mm	20mm Rebated	Flush	Stainless	\$1260.00
FB2SF		1 x Standard Double Socket Outlet	1 x Standard Double Data Plate	240 x 150 x 110mm	266 x 176mm	N/A	Surface	Stainless	\$882.00
FB4SQR		2 x Standard Double Socket Outlets	2 x Standard Double Data Plates	240 x 240 x 110mm	266 x 266mm	6mm Rebated	Flush	Stainless	\$1155.00
FB4SQF70		4 x Auto Switched Socket Outlets	6 x Modular Data Mounts	240 x 240 x 70mm	266 x 266mm	N/A	Flush	Brass	\$1102.50

FLOORBOXES - FLUSH AND SURFACE

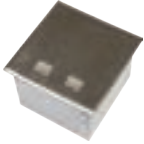

Robust Design

Cable Shield Options

Order Code		Power	Data	Box Size (HxWxD)	Lid Size (HxWxD)	Rebate	Lid Position	Lid Finish	Price excl. GST.
FB4SQR70		4 x Auto Switched Socket Outlets	6 x Modular Data Mounts	240 x 240 x 70mm	266 x 266mm	6mm Rebated	Flush	Stainless	\$1260.00
FB142		2 x Auto Switched Socket Outlets	N/A	135 x 126 x 70mm	145 x 145mm	N/A	Surface	Brass	\$572.25
FB143		2 x Auto Switched Socket Outlets	N/A	135 x 126 x 70mm	145 x 145mm	N/A	Surface	Stainless	\$514.50
FB148		1 x Standard Double Socket Outlet	3 x Modular Data Mounts	135 x 126 x 95mm	145 x 145mm	N/A	Surface	Stainless	\$525.00
FB4SF		2 x Standard Double Socket Outlet	2 x Standard Double Data Plates	240 x 240 x 110mm	266 x 266mm	N/A	Surface	Stainless	\$955.50
FB4SF70		4 x Auto Switched Socket Outlets	6 x Modular Data Mounts	240 x 240 x 70mm	266 x 266mm	N/A	Surface	Stainless	\$1050.00
FB2SF70		2 x Auto Switched Socket Outlets	3 x Modular Data Mounts	240 x 150 x 70mm	266 x 176mm	N/A	Surface	Stainless	\$1102.50
FB6SF		3 x Standard Double Socket Outlet	3 x Standard Double Data Plates	360 x 240 x 110mm	386 x 266mm	N/A	Surface	Stainless	\$1312.50



FLOORBOXES - FLUSH, EXTRA REBATED

Flush Lid
PositionStainless
20mm
Rebated
Lid

Order Code		Power	Data	Box Size (HxWxD)	Lid Size (HxWxD)	Price excl. GST.
FB2SDR		1 x Standard Double Socket Outlet	1 x Standard Double Data Plate	240 x 150 x 133mm	250 x 160 x 38mm	\$1155.00
FB4SDR		2 x Standard Double Socket Outlets	2 x Standard Double Data Plates	240 x 240 x 133mm	250 x 250 x 38mm	\$1286.25
FB4SDR70		4 x Auto Switched Socket Outlets	6 x Modular Data Mounts	240x 240 x 93mm	250x 250 x 38mm	\$1706.25

FLOORBOXES - RECESSED/REBATED

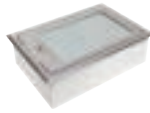
Surface Lid
PositionStainless
6mm
Rebated
Lid

Order Code		Power	Data	Box Size (HxWxD)	Lid Size (HxWxD)	Price excl. GST.
FB6SR		3 x Standard Double Socket Outlets	3 x Standard Double Data Plates	360 x 240 x 110mm	386 x 266mm	\$1312.50
FB4SR		2 x Standard Double Socket Outlets	2 x Standard Double Data Plates	240 x 240 x 110mm	266 x 266mm	\$997.50
FB4SR70		4 x Auto Switched Socket Outlets	6 x Modular Data Mounts	240x 240 x 70mm	266 x 266mm	\$1102.50

FLOORBOXES - POLYAMIDE



Order Code		Power	Data	Box Size (HxWxD)	Lid Size (HxWxD)	Price excl. GST.
FB2P		1 x Standard Double Socket Outlet	1 x Standard Double Data Plate	240 x 150 x 110mm	266 x 176mm	\$483.00
FB2P70		2 x Auto Switched Socket Outlets	3 x Modular Data Mounts	240 x 150 x 70mm	266 x 176mm	\$493.50
FB4P		2 x Standard Double Socket Outlets	2 x Standard Double Data Plates	240x 240 x 110mm	266 x 266mm	\$546.00
FB4P70		4 x Auto Switched Socket Outlets	6 x Modular Data Mounts	240x 240 x 70mm	266 x 266mm	\$525.00
FB6P		3 x Standard Double Socket Outlets	3 x Standard Double Data Plates	360x 240 x 110mm	386 x 266mm	\$630.00
FB6P70		8 x Auto Switched Socket Outlets	8x Modular Data Mounts	360x 240 x 70mm	386 x 266mm	\$913.50



LOPEZ DOWNLIGHTS

We've taken our Jolie downlight and made it slimmer to fit in those tight roof spaces.

With a depth of just 47mm, the new Lopez fits perfectly under a ceiling truss.

Easy to install with quick connect terminals, or flex & plug (LOPEZF), the range has 3 colour settings, is dimmable and a 100° beam angle.

The Lopez downlights are safe to use around insulation with IP54, IC-F and IC-4 ratings, and is perfect for a wide range of applications.



Architectural Lighting	40
Sensors	44
Steplights	45
Downlights	46
Surface Mounted Lights	51
Panels	54
Interior Battens	55
Underverandaahs	57
Floodlights	58



HIP

Supplied
100%
Pre-built

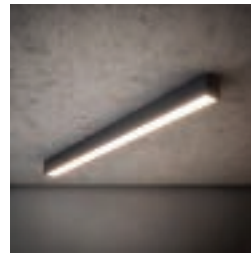

HIP Suspended

HIP Surface Mounted

HIP Wall

Product	Finish	Lens	Light Source	Colour Temp	Price excl. GST	Material
HIP SUS	Black White Silver	Opal V Deglaring Asymmetric Narrow	Tridonic STARK LED	2700K 3000K 4000K	\$POA	Body: Extruded aluminium End caps: Machined aluminium Lens: Extruded acrylic
HIP SM	Black White Silver	Opal V Deglaring Asymmetric Narrow	Tridonic STARK LED	2700K 3000K 4000K	\$POA	
HIP WALL	Black White Silver	Opal V Deglaring Asymmetric Narrow	Tridonic STARK LED	2700K 3000K 4000K	\$POA	

MRS.T RADII

Supplied
100%
Pre-built

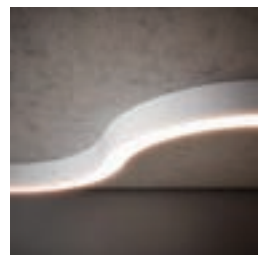

MRS.T RADII Suspended

HIP Surface Mounted

Product	Finish	Lens	Light Source	Colour Temp	Price excl. GST	Material
MRS.T RADII SUS	Black - White Powdercoat	Opal V	Tridonic STARK LED	2700K 3000K 4000K	\$POA	Body: Extruded aluminium End caps: Machined aluminium Lens: Extruded acrylic
MRS.T RADII SM	Black - White Powdercoat	Opal V	Tridonic STARK LED	2700K 3000K 4000K	\$POA	

DARKON PROJECTS QUOTED THROUGH PDC. ENQUIRE WITH SALES_TEAM@PDC.CO.NZ

SLIM C

Supplied
100%
Pre-built



SLIM C Suspended

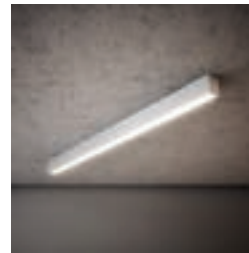

SLIM C Surface Mounted



SLIM C Wall

Product	Finish	Lens	Light Source	Colour Temp	Price excl. GST	Material
SLIM C SUS	Black	Opal V Deglaring Asymmetric Narrow	Tridonic STARK LED	2700K	\$POA	Body: Extruded aluminium End caps: Machined aluminium Lens: Extruded acrylic
	White			3000K		
	Silver			4000K		
SLIM C SM	Black	Opal V Deglaring Asymmetric Narrow	Tridonic STARK LED	2700K	\$POA	Body: Extruded aluminium End caps: Machined aluminium Lens: Extruded acrylic
	White			3000K		
	Silver			4000K		
SLIM C WALL	Black	Opal V Deglaring Asymmetric Narrow	Tridonic STARK LED	2700K	\$POA	Body: Extruded aluminium End caps: Machined aluminium Lens: Extruded acrylic
	White			3000K		
	Silver			4000K		

SUPER MINI GRAZER

Supplied
100%
Pre-built

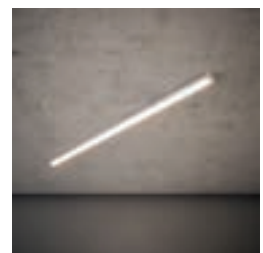

HIP Surface Mounted

Product	Finish	Lens	Light Source	Colour Temp	Price excl. GST	Material
SUPER MINI GRAZER SM	Black White Silver	Opal V	DPAL40 LED	3000K 4000K	\$POA	Body: Extruded aluminium End caps: Machined aluminium Lens: Extruded acrylic

BRANDO RECESSED

Custom Depths Available

Custom Colours Available

Frame and Panel Light Included



Order Code	Suspended Ceiling Cut Out (L x W)	Depth of Light to Ceiling	Finish Colour	Price excl. GST	LED Lifetime	Operating Temp (°C)
SHALLOW					50,000 hrs	-25 to 45°C
PB66RS	575 x 575mm	45mm	White	POA		
PB123RS	1175 x 275mm	45mm	White	POA		
PB126RS	1175 x 575mm	45mm	White	POA	Material Body: Aluminium Lens: PMMA	
DEEP						
PB66RD	575 x 575mm	71mm	White	POA	Carton Qty Box Qty: 1	
PB123RD	1175 x 275mm	71mm	White	POA		
PB126RD	1175 x 575mm	71mm	White	POA		

BRANDO PANELS



Double Insulated

95+
CRI

IP40

220 to
240V AC

90°
Beam
Angle

UGR <19

Flicker
Free



LIGHTING

Order Code	Finish	Typical Power	Lumen Output	Efficacy	Overall Size (H x W x D)	Colour Temp	Price excl. GST	LED Lifetime	Operating Temp (°C)
PB664	White	40W	4,000lm	100lm/W	595 x 595 x 32mm	4000K	POA	50,000 hrs	-25 to 45°C
PB1234	White	40W	4,000lm	100lm/W	1,195 x 295 x 32mm	4000K	POA		
PB1264	White	40W	4,000lm	100lm/W	1,195 x 595 x 32mm	4000K	\$158.58		

Material
Body: Aluminium
Lens: PMMA

Carton Qty
Box Qty: 1
Shipper Qty: 6 PB664, PB1234
Shipper Qty: 4 PB1264

SURFACE MOUNT KITS

Order Code	Description	Price excl. GST
PB66SK	Surface Mount Kit For PB664	\$106.50
PB123SK	Surface Mount Kit For PB1234	\$131.50
PB126SK	Surface Mount Kit For PB1264	\$152.95

MOSS SENSORS

IP44	220 to 240V AC	360° PIR	400W Motor/Fan
450W Fluorescent	2000W Incandescent	400W LED	



Order Code	Fascia Colour	Fascia Size	Detection Range	Cut-out	Time Adjustment	Lux Adjustment	Price excl. GST	Material
FLUSH								
VMOSS	White	Ø 74mm	Ø 6m at 2.4m height	Ø 60mm	5 secs to 30 mins	10 to 2000Lux	\$73.42	Body: Polycarbonate Lens: HDPE
VMOSSB	Black	Ø 74mm	Ø 6m at 2.4m height	Ø 60mm	5 secs to 30 mins	10 to 2000Lux	\$80.76	Carton Qty Box Qty: 1 Shipper Qty: 100

FEATURES

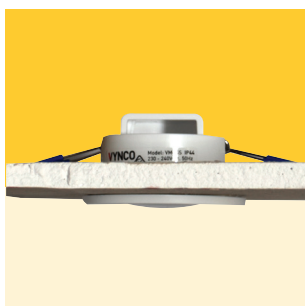

Low profile fascia provides unobtrusive option



White aesthetic finish, matches McQueen downlight range



Controls under fascia

DIAZ STEPLIGHTS

Dimmable

80+
CRI

IP44
Front Only

220 to
240V AC

90°
Beam
Angle

IC-F
Rated
Driver

IC-4
Rated
Driver

3CCT
version
coming
soon



Order Code	Fascia Colour	Range	Typical Power	Lumen Output	Fascia Size (H x W)	Colour Temp	Price excl. GST
FLUSH SINGLE COLOUR							
VST1	White Gloss	Urban	3W	56lm	116 x 78mm	3000K	\$141.40
VST1B	Black Metal	Urban	3W	18lm	116 x 78mm	3000K	\$154.27
VST1S	Silver Metal	Urban	3W	38lm	116 x 78mm	3000K	\$154.27
VST1M	White Satin	Metro	3W	38lm	120 x 82mm	3000K	\$98.42
VST1MB	Black Satin	Metro	3W	16lm	120 x 82mm	3000K	\$118.10

LED Lifetime >50,000 hrs

Operating Temp (°C) -20 to 45°C

Material

Fascia:
Aluminium (Black / Silver)
or
Polycarbonate (White / Black Satin)

Back:
Polycarbonate

Carton Qty

Box Qty: 1
Shipper Qty: 48

FEATURES

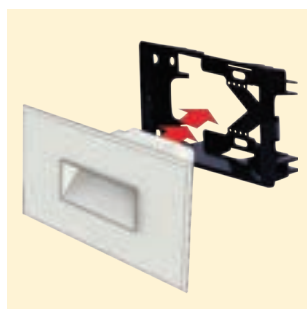



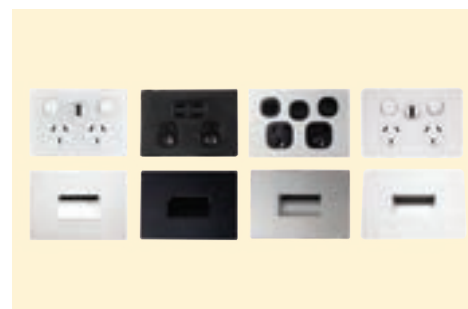



Fits into standard flush boxes, saving time at installation



Matches Urban and Fusion and Metro switchgear

MCQUEEN DOWNLIGHTS

 Dimmable	 80+ CRI	 IP44 Front Only	 200 to 240V AC
 IK06	 IC-F Rated Driver	 IC-4 Rated Driver	



Order Code	Fascia Colour	Typical Power	Lumen Output	Fascia Size	Cut-out Size	Colour Temp	Price excl. GST
FLUSH SINGLE COLOUR							
MCQUEEN33A	White	8W	700lm	Ø 104mm	Ø 90 to 95mm	3000K	\$82.73
FLUSH COLOUR CHANGE							
MCQUEEN3	White	8W	700 to 750lm	Ø 104mm	Ø 90 to 95mm	3000K 4000K 5700K	\$85.21
M4	White	12W	900 to 1,000lm	Ø 130mm	Ø 105 to 110mm	3000K 4000K 5700K	\$159.95



LED Lifetime	Operating Temp (°C)
>40,000 hrs	-25 to 45°C
Material	
Body: Aluminium	
Carton Qty	
Box Qty: 1 Shipper Qty: 24 MCQUEEN33A/MCQUEEN3	
Box Qty: 1 Shipper Qty: 30 M4	

FEATURES



Slim 31mm body fits easily under trusses

MCQUEEN DOWNLIGHTS

 Dimmable	 80+ CRI	 IP44 Front Only M3R/M3RB M33R	 IP54 Front Only M5R/M6R M8R	 200 to 240V AC
 Includes flex & plug M5R/M6R & M8R	 90° Beam Angle	 IK06	 *IC-F Rated Driver	 *IC-4 Rated Driver



Order Code	Fascia Colour	Typical Power	Lumen Output	Fascia Size	Cut-out Size	Colour Temp	Price excl. GST
RECESSED SINGLE COLOUR							
*M33R	White	8W	700lm	Ø 110mm	Ø 90 to 100mm	3000K	\$91.17
RECESSED COLOUR CHANGE							
*M3R	White	8W	700 to 750lm	Ø 110mm	Ø 90 to 100mm	3000K 4000K 5700K	\$91.17
*M3RB	Black	8W	700 to 750lm	Ø 110mm	Ø 90 to 100mm	3000K 4000K 5700K	\$91.17
M6R	White	18W	1,800 to 1,980lm	Ø 170mm	Ø 140 to 150mm	3000K 4000K 5700K	\$235.64
M8R	White	35W	3,500 to 4,000lm	Ø 228mm	Ø 200 to 210mm	3000K 4000K 5700K	\$252.32

LED Lifetime	Operating Temp [°C]
>40,000 hrs	-25 to 45°C
Material	
Body: Aluminium	
Carton Qty	
Box Qty: 1 Shipper Qty: 24 M3R, M3RB, M33R	
Box Qty: 1 Shipper Qty: 30 M6R, M8R	

FEATURES



Slim 38mm body fits easily under trusses*

*38mm only applies to M3R and M3RB. M5R, M6R and M8R are 45mm.

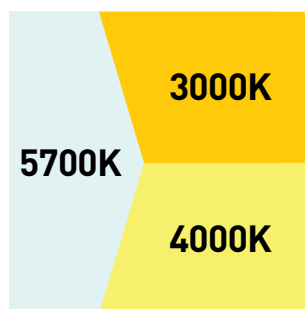

Tri-colour
Except for M33R

MCQUEEN DOWNLIGHTS

Dimmable	80+ CRI	IP20	200 to 240V AC
IK06	90° Beam Angle	IC-F Rated Driver	IC-4 Rated Driver



Order Code	Fascia Colour	Typical Power	Lumen Output	Tilt Angle	Fascia Size	Cut-out Size	Colour Temp	Price excl. GST
GIMBLE COLOUR CHANGE								
M3G	White	10W	700 to 800lm	25°	Ø 104mm	Ø 90 to 95mm	3000K 4000K 5700K	\$94.62
M3GB	Black	10W	700 to 800lm	25°	Ø 104mm	Ø 90 to 95mm	3000K 4000K 5700K	\$100.30

LED Lifetime	Operating Temp (°C)
>40,000 hrs	-25 to 45°C
Material	
Body: Aluminium	
Carton Qty	
Box Qty: 1 Shipper Qty: 24	

FEATURES



Slim 31mm body fits easily under trusses

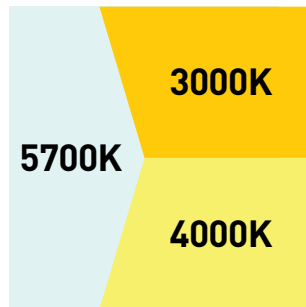



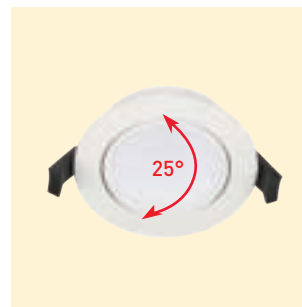



Tri-colour

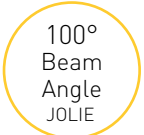
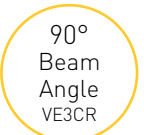

25° tiltable head

JOLIE DOWNLIGHTS

 Dimmable	 80+ CRI	 IP54 Front Only	 200 to 240V AC	 Includes flex & plug VE3CR
 100° Beam Angle JOLIE	 90° Beam Angle VE3CR	 IC-F Rated Driver	 IC-4 Rated Driver	



Order Code	Fascia Colour	Typical Power	Lumen Output	Fascia Size	Cut-out Size	Colour Temp	Price excl. GST
FLUSH COLOUR CHANGE							
JOLIE	White	8W	860 to 900lm	Ø 115mm	Ø 90 to 100mm	3000K 4000K 5700K	\$45.47
RECESSED COLOUR CHANGE							
VE3CR	White	8W	750 to 800lm	Ø 115mm	Ø 90 to 100mm	3000K 4000K 5700K	\$48.94

LED Lifetime	Operating Temp [°C]
>40,000 hrs	-20 to 45°C
Material	
Body: Polycarbonate	
Carton Qty	
Box Qty: 1 Shipper Qty: 30	

FEATURES



Includes 0.6m flex and plug for VE3CR

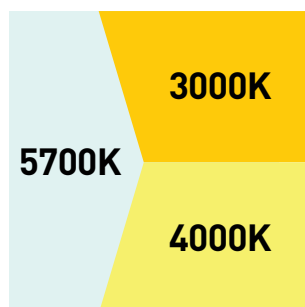

Tri-colour

LOPEZ DOWNLIGHTS



Dimmable	80+ CRI	IP54 Front Only	200 to 240V AC
LOPEZF Includes flex & plug	100° Beam Angle	IC-F Rated Driver	IC-4 Rated Driver



Order Code	Fascia Colour	Typical Power	Lumen Output	Fascia Size	Cut-out Size	Colour Temp	Price excl. GST
FLUSH COLOUR CHANGE							
LOPEZ	White	8W	860 to 920lm	Ø 110mm	Ø 90 mm	3000K 4000K 5700K	\$35.50
LOPEZB	Black	8W	860 to 920lm	Ø 110mm	Ø 90 mm	3000K 4000K 5700K	\$35.50
LOPEZF*	White	8W	860 to 920lm	Ø 110mm	Ø 90 mm	3000K 4000K 5700K	\$37.50

LED Lifetime	>40,000 hrs
Operating Temp (°C)	-20 to 45°C
Material	
Body: Polycarbonate	
Carton Qty	
Box Qty: 1 Shipper Qty: 30	

*LOPEZF Includes flex & plug

FEATURES

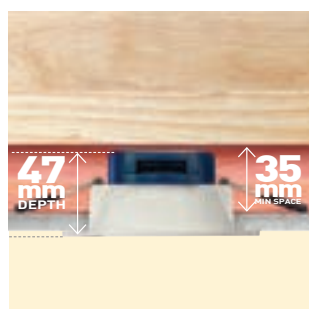

Designed to fit into tight roof spaces

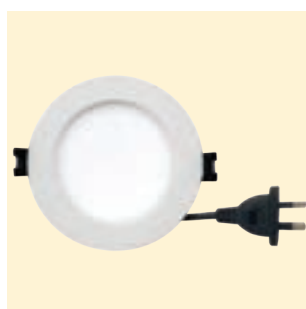

Includes driver flex and plug for LOPEZF

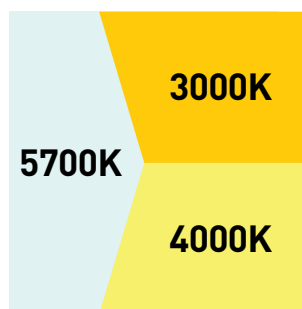

Tri-colour

CRAWFORD OYSTERS - ROUND

Dimmable

80+
CRI

IP54

200 to
240V AC

IK08

120°
Beam
Angle

Double
Insulated



LIGHTING

Order Code	Finish	Typical Power	Lumen Output	Overall Size (Ø x D)	Colour Temp	Price excl. GST
SURFACE COLOUR CHANGE						
V0122	White	12W	1,000 to 1,070lm	Ø 250mm x 54mm	3000K 4000K 5700K	\$96.71
V0183	White	18W	1,760 to 1,900lm	Ø 300mm x 54mm	3000K 4000K 5700K	\$111.78
V0253	White	25W	2,320 to 2,470lm	Ø 300mm x 54mm	3000K 4000K 5700K	\$141.15
V0304	White	30W	2,700 to 3,000lm	Ø 400mm x 60mm	3000K 4000K 5700K	\$158.39

LED Lifetime	Operating Temp (°C)
>40,000 hrs	-25 to 45 °C
Material	
Body: Polycarbonate	
Carton Qty	
Box Qty: 1 Shipper Qty: 10 V0183, V0253, V0304	
Box Qty: 1 Shipper Qty: 20 V0122	

FEATURES

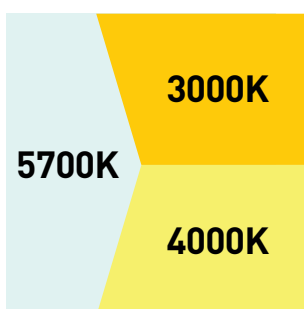

Tri-colour

CRAWFORD OYSTERS - SQUARE

Dimmable

80+
CRI

IP54

200 to
240V AC

IK08

120°
Beam
Angle

Double
Insulated



Order Code	Finish	Typical Power	Lumen Output	Overall Size (H x W x D)	Colour Temp	Price excl. GST
SURFACE COLOUR CHANGE						
VOS1225	White	12W	1,200 to 1,330lm	250 x 250 x 50mm	3000K 4000K 5700K	\$85.68
VOS1830	White	18W	1,800 to 1,995lm	300 x 300 x 40mm	3000K 4000K 5700K	\$106.48
VOS2530	White	25W	2,500 to 2,775lm	300 x 300 x 40mm	3000K 4000K 5700K	\$120.52
VOS3040	White	30W	3,000 to 3,300lm	400 x 400 x 50mm	3000K 4000K 5700K	\$164.58

LED Lifetime	Operating Temp (°C)
>40,000 hrs	-25 to 45°C
Material	
Body: Polycarbonate	
Carton Qty	
Box Qty: 1 Shipper Qty: 10 VOS1830, VOS2530, VOS3040	
Box Qty: 1 Shipper Qty: 20 VOS1225	

FEATURES

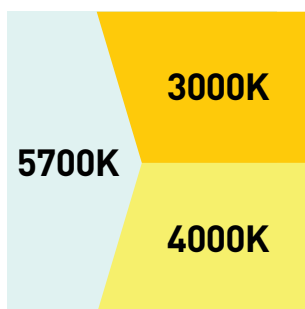

Tri-colour

OCEAN OYSTER

80+
CRI

IP54

200 to
240V AC

Adjustable
Wattage

IK08

120°
Beam
Angle

Double
Insulated



MADE FROM
RECYCLABLE AND
BIO MATERIALS



LIGHTING

Order Code	Finish	Typical Power	Lumen Output	Overall Size (Ø x D)	Colour Temp	Price excl. GST
SURFACE COLOUR CHANGE						
LOC275	White	6/12/18W	660 to 1,980lm	Ø 275mm x 48mm	3000K 4000K 5700K	POA
LOC350	White	15/20/24W	1650 to 2,640lm	Ø 350mm x 48mm	3000K 4000K 5700K	POA

LED Lifetime	Operating Temp (°C)
>50,000 hrs	-20 to 45°C
Material	
Body: Polycarbonate	
Carton Qty	
Box Qty: LOC275 12 Units	
Box Qty: LOC350 10 Units	

FEATURES

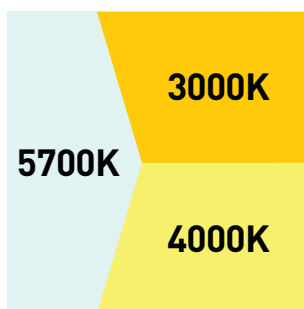

Tri-colour

GARCIA LED PANELS



Double Insulated

80+
CRI

IP40

220 to
240V AC

120°
Beam
Angle

UGR <22



Order Code	Finish	Typical Power	Lumen Output	Efficacy	Overall Size (H x W x D)	Colour Temp	Price excl. GST
COLOR CHANGE							
P66	White	33W	3,600 to 3,900lm	115lm/W	595 x 595 x 9mm	4000K 5700K	\$295.06
P123	White	33W	3,000 to 3,300lm	100lm/W	1,195 x 295 x 9mm	4000K 5700K	\$313.89

LED Lifetime	Operating Temp (°C)
40,000 hrs	-20 to 45°C

Material

Body: Aluminium

Lens: PMMA LGP (Light Guide Plate)

Carton Qty

Box Qty: 1
Shipper Qty: 5

FEATURES

4000K

5700K

Dual colour

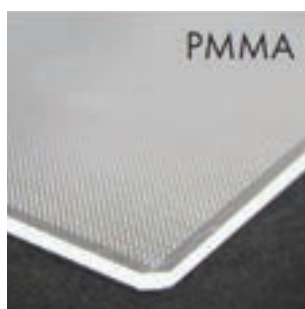

PMMA Light Guide Plate (LGP)

OLSEN BATTENS

220 to 240V AC	80+ CRI	IP20
Non Dimmable	120° Beam Angle	IK08



Order Code	Finish	Typical Power	Lumen Output	Overall Size (L x W x D)	Colour Temp	Price excl. GST	LED Lifetime	Operating Temp (°C)
SURFACE SINGLE COLOUR							>50,000 hrs	-20 to 45°C
OLSEN5	White	50W	6,000lm	1,500 x 71 x 63mm	4000K	\$115.04		
SURFACE COLOUR CHANGE							Material	
OLSEN245	White	20W	1,900 to 2,060lm	600 x 71 x 63mm	4000K 5700K	\$68.05	Body: Aluminium Lens: PC Opal	
OLSEN445	White	40W	4,000 to 4,400lm	1,200 x 71 x 63mm	4000K 5700K	\$117.90	Carton Qty	
OLSEN545	White	50W	5,800 to 6,000lm	1,500 x 71 x 63mm	4000K 5700K	\$144.10	Box Qty: 1 Shipper Qty: 12	

FEATURES



Easy install base, clips to release base and lens



Toolless centre mains entry



Knock outs at both ends, suitable for alternative installation methods



IP20 base, and IP54 body to help protect against dust, water, and insects

MONROE BATTENS

80+ CRI	IP20	220 to 240V AC
Non Dimmable	110° Beam Angle	IK03



Order Code	Finish	Typical Power	Lumen Output	Efficacy	Size (H x W x D)	Colour Temp	Price excl. GST
SURFACE SINGLE COLOUR							
B1224	White	50W	5,500lm	110lm/W	1,188 x 208 x 70mm	4000K	\$276.34
B1524	White	70W	7,500lm	110lm/W	1,488 x 208 x 70mm	4000K	\$311.51
SURFACE SINGLE COLOUR EMERGENCY							
B1224E	White	50W* / 4W**	5,500lm* / 440lm**	110lm/W	1,188 x 208 x 70mm	4000K	\$639.90
B1524E	White	70W* / 4W**	7,500lm* / 440lm**	110lm/W	1,488 x 208 x 70mm	4000K	\$685.96

LED Lifetime	Operating Temp (°C)
>50,000 hrs	-30 to 50°C
Material	
Body: Powder Coated Steel	
Lens: PC	
Carton Qty	
Box Qty: 1 Shipper Qty: 5	

*Standard lumen output and power **Emergency lumen output and power
Emergency unit: 3 hour emergency operation / 24 hours recharge time / intelligent automatic recharge function / test switch.

FEATURES



Flicker-free
Osram driver



Wide body ideal
for retrofitting

CONNERY UNDERVERANDAHS

80+ CRI	IP65	220 to 240V AC	2CCT 4000 K 6500 K
120° Beam Angle	IK08	Non Dimmable	



Order Code	Finish	Typical Power	Lumen Output	Efficacy	Overall Size (H x W x D)	Colour Temp	Price excl. GST	LED Lifetime	Operating Temp (°C)
SURFACE COLOUR CHANGE									
VU246	Grey	20W	2,030 to 2050lm	100lm/W	660 x 158 x 102mm	4000K 6500K	\$116.38	>50,000 hrs	-20 °C to 45 °C
VU446	Grey	38W	3,765 to 3850lm	100lm/W	1,270 x 158 x 102mm	4000K 6500K	\$192.76		
VU546	Grey	50W	5,095 to 5,620lm	100lm/W	1,570 x 158 x 102mm	4000K 6500K	\$231.55		
SURFACE COLOUR CHANGE EMERGENCY									
VU446E	Grey	38W*/ 4W**	3,765 to 3,850Lm* / 400Lm**	100lm/W	1270 x 158 x 102mm	4000K 6500K	\$598.22	Box Qty: 1 Shipper Qty: 4 VU446 & VU546	
VU546E	Grey	50W*/ 4W**	5,095 to 5,620lm* / 400lm**	100lm/W	1570 x 158 x 105mm	4000K 6500K	\$665.39		Shipper Qty: 8 VU246

Material

Body: ABS

Lens: PC

Carton Qty

*Standard lumen output and power **Emergency lumen output and power

Emergency unit: 3 hour emergency operation / 24 hours recharge time / intelligent automatic recharge function / test switch.

FEATURES

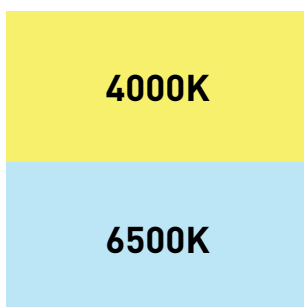

Dual colour



Wide body is ideal for retrofitting



Emergency and sensing options available

WILLIS FLOODLIGHTS

Class 1	75+ CRI	IP66
230V AC	120° Beam Angle	IK08



Order Code	Finish	Typical Power	Lumen Output	Efficacy	Overall Size (H x W x D)	Colour Temp	Price excl. GST
SURFACE SINGLE COLOUR							
WILLIS10	Black	10W	1,000lm	100lm/W	115 x 186 x 21mm	5000K	\$87.62
WILLIS30	Black	30W	3,000lm	100lm/W	115 x 186 x 21mm	5000K	\$157.71
WILLIS50	Black	50W	6,000lm	120lm/W	200 x 211 x 30mm	5000K	\$205.00
WILLIS100	Black	100W	12,000lm	120lm/W	250 x 260 x 30mm	5000K	\$238.06
WILLIS150	Black	150W	18,000lm	120lm/W	313 x 309 x 35mm	5000K	\$343.72
WILLIS200	Black	200W	24,000lm	120lm/W	448 x 386 x 37mm	5000K	\$461.63

LED Lifetime	Operating Temp (°C)
---------------------	----------------------------

>60,000 hrs -25 to 45 °C

Material

Body: Aluminium + Steel

Lens: Glass

Carton Qty

Box Qty: 1
 Shipper Qty:
 36
 (WILLIS10 & WILLIS30)
 16
 (WILLIS50)
 10
 (WILLIS100)
 6
 (WILLIS150)
 4
 (WILLIS200)

FEATURES

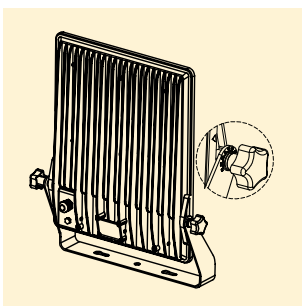

Toolless adjustment

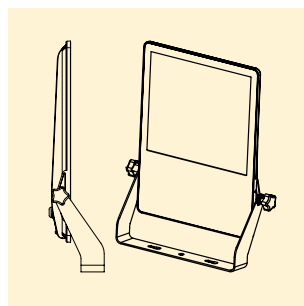

Slim profile



Bracket designed to be easily fixed to a structure without having to remove the light



Diaz Steplights



VYNCO

FOLEY EXTERNAL COWL GRILLES

The Foley Grille offers a modern, unobtrusive alternative to traditional plastic exterior cowls. With a robust aluminium body, powdercoated in one of three standard colours, the grille will not discolour with exposure to UV light.

Personalisation is available with custom powdercoat colour options.

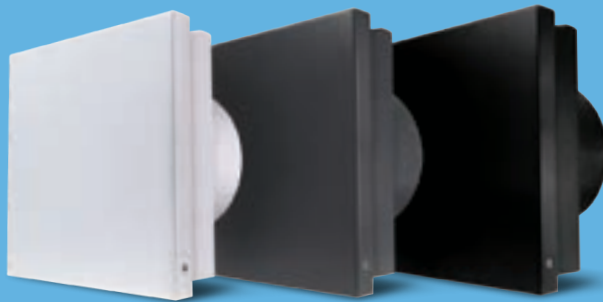

- Custom powdercoat colour options
- Airflow tested
- Sound tested to ISO7235 & ISO3741 standards
- Minimum 15 year lifetime to match requirements of other cladding components as defined in the NZBC B2
- Designed, manufactured and tested at our Christchurch facility

Interior Grilles	62
Exterior Grilles	67
Architectural Grille + Fan	71
Fans	72
Fan Kits	76
Ducts	80
Accessories	81

AIR MOVEMENT





ILLUSION GRILLE

Indoor Use Only

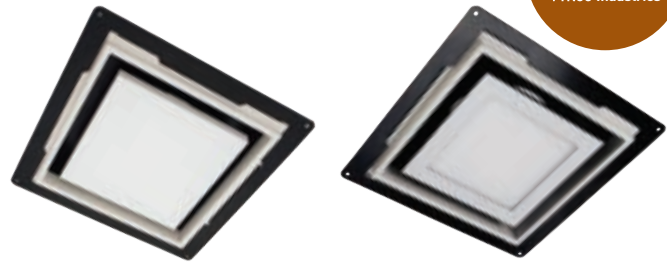

AIR MOVEMENT

Order Code	Finish	Duct Size	Overall Size (L x W x D)	Cut-out Size	Price excl. GST
ILLUSION GRILLE					
VIG2	White*	Ø 150mm	330 x 330 x 123mm	268 x 268mm	\$551.99

*Centre tile can be painted

Mounting

Wall / Ceiling Mounted

Material

Frame: Powder Coated Steel + Reinforced Plaster

Centre Tile: MDF

Order Code	Finish	Duct Size	Lumen Output	Overall Size (L x W x D)	Cut-out Size	Colour Temp	Price excl. GST
ILLUSION GRILLE WITH LIGHT							
VIG2L	White	Ø 150mm	780 to 850lm	330 x 330 x 123mm	268 x 268mm	3000K 4000K 5700K	\$636.47

FEATURES

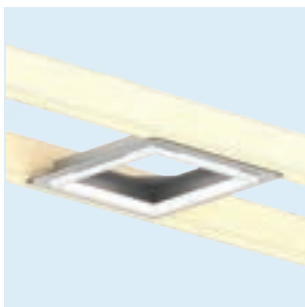

Fits securely to ceiling framing rather than over plasterboard

Can be done at the prewire stage



Tapered plastic spigot for easy attachment of ducting

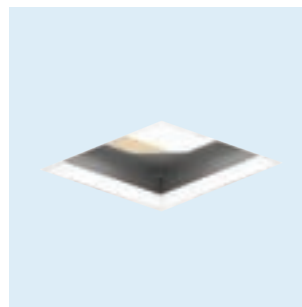

Plaster fascia surround ensures seamless finish of plaster sticking to plaster to reduce chance of cracking

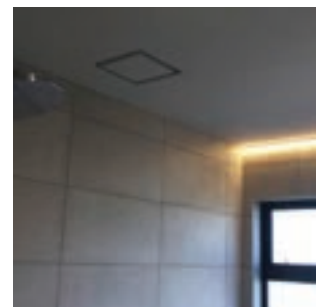

Invisible appearance when installed

BOND GRILLES - WHITE

Indoor Use Only



Designers Institute of New Zealand Best Design Awards Winner 2019

Order Code	Finish	Description	Duct Size	Fascia Size	Cut-out Size	Price excl. GST
BASE + ROUND GRILLE*						
VBG009	White	Grille Base + Round Grille	Ø 150mm	Ø 212mm	Ø 185mm	\$57.39
BASE ONLY*						
VBG001	White	Grille Base	Ø 150mm	Ø 212mm	Ø 185mm	\$34.43
GRILLE ONLY*						
VBG002	White	Square Grille	Ø 150mm	260 x 260mm	-	\$22.95
VBG004	White	Round Grille	Ø 150mm	Ø 173mm	-	\$22.95

Operating Temp (°C)	-20 to 80°C
Mounting	Ceiling Mounted
Material	ABS

*Purchase as a complete base and grille, or as two separate parts.

FEATURES



Extended tapered spigot for ease of taping duct

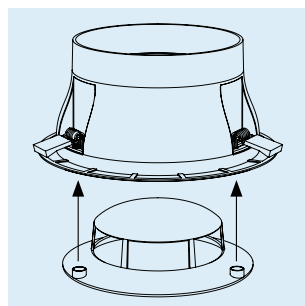

Magnetic grille fascia for easy attachment

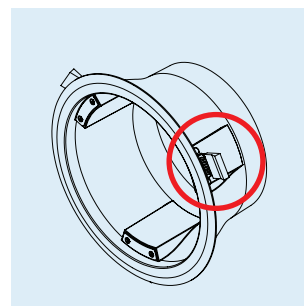

Specially designed installation clips

BOND GRILLES - BLACK

Indoor
Use Only



Base

Round

Square



Designers Institute
of New Zealand
Best Design Awards
Winner 2019



DESIGN
REGISTRATION
VYNCO Industries

AIR MOVEMENT

Order Code	Finish	Description	Duct Size	Fascia Size	Cut-out Size	Price excl. GST
BASE + ROUND GRILLE*						
VBG010	Black	Grille Base + Round Grille	Ø 150mm	Ø 212mm	Ø 185mm	\$57.39
BASE ONLY*						
VBG005	Black	Grille Base	Ø 150mm	Ø 212mm	Ø 185mm	\$34.43
GRILLE ONLY*						
VBG006	Black	Square Grille	Ø 150mm	260 x 260mm	-	\$22.95
VBG008	Black	Round Grille	Ø 150mm	Ø 173mm	-	\$22.95

Operating Temp (°C)

-20 to 80°C

Mounting

Ceiling Mounted

Material

ABS

*Purchase as a complete base and grille, or as two separate parts.

FEATURES



Extended tapered spigot for ease of taping duct

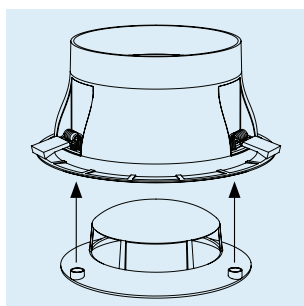

Magnetic grille fascia for easy attachment

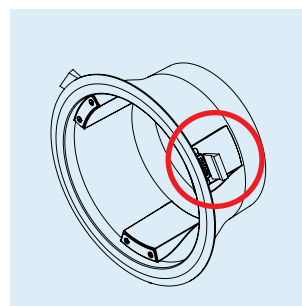

Specially designed installation clips

REACHER GRILLES - ROUND



Order Code	Finish	Duct Size	Facia Size	Cut-out Size	Price excl. GST
VGR150SRW	White Satin	Ø 150mm	Ø 200mm	Ø 159mm	\$32.95
VGR150SRB	Black Satin	Ø 150mm	Ø 200mm	Ø 159mm	\$31.52
VGR125SRW	White Satin	Ø 125mm	Ø 175mm	Ø 140mm	\$36.11
VGR125SRB	Black Satin	Ø 125mm	Ø 175mm	Ø 140mm	\$39.91

Operating Temp (°C)	-20 to 80°C
Mounting	Wall / Ceiling Mounted
Material	ABS

AIR MOVEMENT

FEATURES



Tapered plastic spigot for easy attachment of ducting



Longer spigot for easy taping



REACHER ROUND GRILLE WITH LIGHT

Dimmable	80+ CRI	IP24 Installed	200-240VAC to Driver	IC-F Rated Driver
IC-4 Rated Driver	90° Beam Angle	IK06	SELV Light fitting	Remote Driver

AIR MOVEMENT

Order Code	Finish	Typical Power	Lumen Output	Duct Size	Overall Size (H x W x D)	Cut Out Size	Colour Temp	Price excl. GST
VGL150RW	White	8W	700 to 750lm	Ø 150mm	Ø 200mm	Ø 159mm	3000K 4000K 5700K	\$184.57

Operating Temp (°C)

-25 to 45°C

Mounting

Ceiling Mounted

Material

Grille: Polycarbonate

Light: Aluminium

Spigot: ABS

FEATURES



Matches MCQUEEN3 downlight range

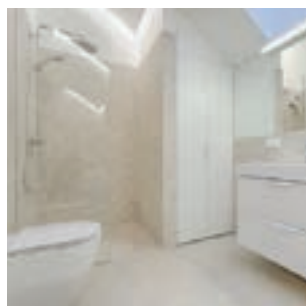

Suitable for use in bathroom zone 1
Showers, Wet Areas

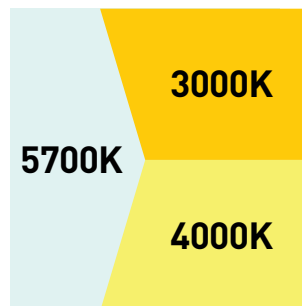

Tri-colour

FOLEY GRILLES - COWL

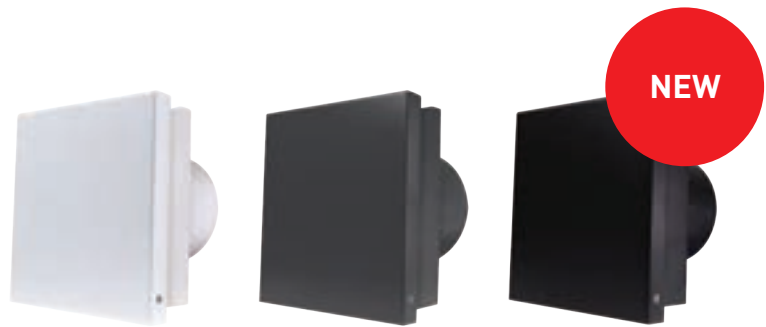

AIR MOVEMENT

Order Code	Grille Colour	Duct Size	Fascia Size (H x W x D)	Cut-out Size	Price excl. GST	Operating Temp (°C)
FOLEY110W	Artic White	Ø 100mm	243 x 226 x 190mm	Ø 108mm	\$291.90	-20 to 70°C
FOLEY110G	Gun Metal Grey	Ø 100mm	243 x 226 x 190mm	Ø 108mm	\$291.90	
FOLEY110B	Textured Black	Ø 100mm	243 x 226 x 190mm	Ø 108mm	\$291.90	
FOLEY112W	Artic White	Ø 125mm	243 x 226 x 190mm	Ø 140mm	\$316.08	Soffit / Wall Mounted
FOLEY112G	Gun Metal Grey	Ø 125mm	243 x 226 x 190mm	Ø 140mm	\$316.08	
FOLEY112B	Textured Black	Ø 125mm	243 x 226 x 190mm	Ø 140mm	\$316.08	
FOLEY115W	Artic White	Ø 150mm	243 x 226 x 190mm	Ø 152mm	\$350.75	Aluminium
FOLEY115G	Gun Metal Grey	Ø 150mm	243 x 226 x 190mm	Ø 152mm	\$350.75	
FOLEY115B	Textured Black	Ø 150mm	243 x 226 x 190mm	Ø 152mm	\$350.75	
FOLEY215W	Artic White	Ø 150mm	293 x 276 x 190mm	Ø 152mm	\$367.67	
FOLEY215G	Gun Metal Grey	Ø 150mm	293 x 276 x 190mm	Ø 152mm	\$367.67	
FOLEY215B	Textured Black	Ø 150mm	293 x 276 x 190mm	Ø 152mm	\$367.67	
FOLEY220W	Artic White	Ø 200mm	293 x 276 x 190mm	Ø 204mm	\$370.50	
FOLEY220G	Gun Metal Grey	Ø 200mm	293 x 276 x 190mm	Ø 204mm	\$370.50	
FOLEY220B	Textured Black	Ø 200mm	293 x 276 x 190mm	Ø 204mm	\$370.50	



REACHER GRILLES - COWL



AIR MOVEMENT

Order Code	Finish	Duct Size	Fascia Size (H x W x D)	Cut-out Size	Price excl. GST	Operating Temp (°C)
VGR150CW	White	Ø 150mm	255 x 186 x 79mm	Ø 156mm	\$70.61	-20 to 80°C
VGR150CB	Black	Ø 150mm	255 x 186 x 79mm	Ø 156mm	\$73.83	
VGR125CW	White	Ø 125mm	255 x 186 x 79mm	Ø 140mm	\$71.24	Wall Mounted
VGR125CB	Black	Ø 125mm	255 x 186 x 79mm	Ø 140mm	\$71.24	Material
VGR100CW	White	Ø 100mm	255 x 186 x 79mm	Ø 114mm	\$68.83	Exterior Grade ABS
VGR100CB	Black	Ø 100mm	255 x 186 x 79mm	Ø 114mm	\$68.83	

FEATURES

Uniform fascia regardless of duct size



Angled slot mounting positions allow adjustment before final tightening, ensuring a straight square finish



Built-in bird prevention grate and silent back-draught shutter

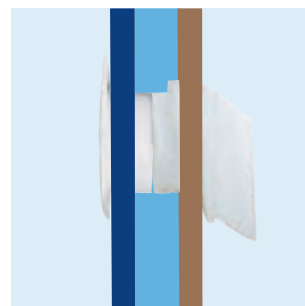

Reduced spigot length for back-to-back installation with a through-wall fan



Straight edges allow for accurate scribing on weatherboard, linear, and rough wall surfaces

REACHER GRILLES - FIXED LOUVRE



AIR MOVEMENT

Order Code	Finish	Duct Size	Fascia Size (H x W x D)	Cut-out Size	Price excl. GST	Operating Temp (°C)
VGR150FW	White	Ø 150mm	184 x 184 x 12.5mm	Ø 159mm	\$27.74	-20 to 80°C
VGR150FB	Black	Ø 150mm	184 x 184 x 12.5mm	Ø 159mm	\$29.00	
VGR125FW	White	Ø 125mm	184 x 184 x 12.5mm	Ø 140mm	\$25.99	Soffit / Wall Mounted
VGR125FB	Black	Ø 125mm	184 x 184 x 12.5mm	Ø 140mm	\$27.17	
VGR100FW	White	Ø 100mm	184 x 184 x 12.5mm	Ø 114mm	\$24.83	Material Exterior Grade ABS
VGR100FB	Black	Ø 100mm	184 x 184 x 12.5mm	Ø 114mm	\$25.97	

FEATURES

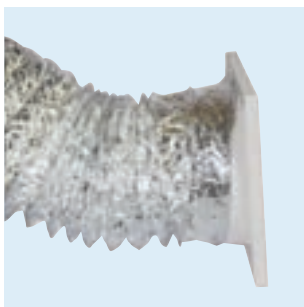

Tapered plastic spigot for easy attachment of ducting



Longer spigot for easy taping

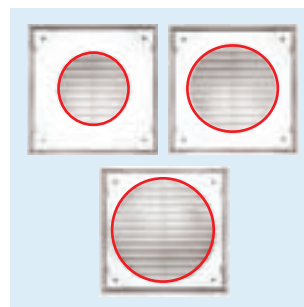

Fascia is the same size regardless of duct size for a uniform aesthetic

BOURNE GRILLES - WHITE



Cowl



Eggcrate



Fixed

AIR MOVEMENT

Order Code	Style	Duct Size	Fascia Size	Cut-out Size	Price excl. GST
VB0150C	Cowl	Ø 150mm	185 x 185mm	Ø 159mm	\$73.89
VB0150E	Eggcrate	Ø 150mm	185 x 185mm	Ø 159mm	\$34.43
VB0150F	Fixed	Ø 150mm	185 x 185mm	Ø 159mm	\$34.43
VB0125C	Cowl	Ø 125mm	185 x 185mm	Ø 133mm	\$67.17
VB0125E	Eggcrate	Ø 125mm	185 x 185mm	Ø 133 mm	\$33.00
VB0125F	Fixed	Ø 125mm	185 x 185mm	Ø 133 mm	\$31.57
VB0100C	Cowl	Ø 100mm	185 x 185mm	Ø 105mm	\$59.12
VB0100E	Eggcrate	Ø 100mm	185 x 185mm	Ø 105 mm	\$33.00
VB0100F	Fixed	Ø 100mm	185 x 185mm	Ø 105 mm	\$31.57

Operating Temp (°C)

-20 to 80°C

Mounting

Cowl: Wall Mounted

Eggcrate: Soffit

Fixed Louvre: Soffit / Wall Mounted

Material

Exterior Grade ABS

FEATURES

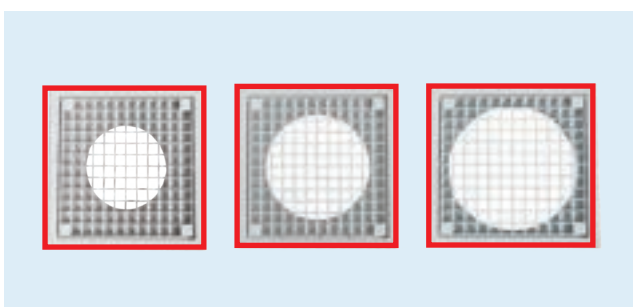

Uniform fascia look regardless of duct size

MAGNUM GRILLE + FAN

IPX4

220-240V AC
at 50Hz

75mm
Cover
Depth



AIR MOVEMENT

Order Code	Finish	Typical Power	Maximum Airflow	Acoustic Sound Level	Duct Size	Overall Size (H x W x D)	Price excl. GST	Operating Temp (°C)
VEF2G	Gunmetal Grey	59W	582m³/h 161.7L/s	64/66dB	Ø 150mm	287 x 287 x 145mm	\$1079.44	-20 to 60°C
VEF2B	Satin Black	59W	582m³/h 161.7L/s	64/66dB	Ø 150mm	287 x 287 x 145mm	\$1079.44	Mounting
VEF2W	Arctic White	59W	582m³/h 161.7L/s	64/66dB	Ø 150mm	287 x 287 x 145mm	\$1079.44	Soffit / Wall Mounted

Material
Powder Coated Aluminium

FEATURES

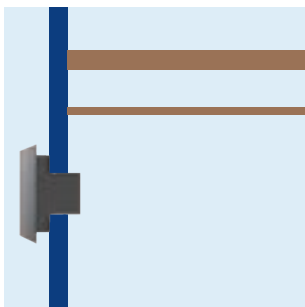

Ideal for narrow ceiling spaces where an in-line fan is too large

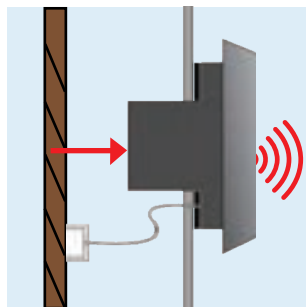

Noise moved to exterior of house



Premium finish gives an appealing aesthetic



Custom powder coating available on request

F35 FANS

IP44

220-240V AC
at 50Hz

Two
Speed

Double
Insulated

Includes
flex & plug



Order Code	Typical Power	Maximum Airflow	Acoustic Sound Level	Pressure Rating	Duct Size	Price excl. GST	Operating Temp (°C)
VAFM1251	28W	248m³/h 68.9L/s	35dB	106Pa	Ø 125mm	\$294.39	-20 to 80°C
	33W	284m³/h 78.8L/s	42dB	159Pa			
VAFM1501	44W	410m³/h 113.9L/s	41dB	240Pa	Ø 150mm	\$353.70	Base Mounted
	54W	530m³/h 147.2L/s	48dB	300Pa			

Mounting

Base Mounted

Material

Housing: ABS

Impeller: PP

FEATURES



Two speed selector switch



Selector switch has adjustable positioning for easy installation



Motor can be removed without disconnecting the ducting

F16 FAN



IP44

230-240V AC
at 50Hz

EC
Motor

Double
Insulated

Includes
flex & plug



Order Code	Typical Power	Maximum Airflow	Acoustic Sound Level	Pressure Rating	Duct Size	Price excl. GST	Operating Temp (°C)
VAF16	20W	410.4m³/h 114L/s	49.9dB	125Pa	Ø 150mm	\$161.61	-10 to 70°C

Mounting

Suspended / Base Mounted

Material

Spigot + Base: ABS
Housing + Impeller: PBT

FEATURES



Easy clip system for base mount installation

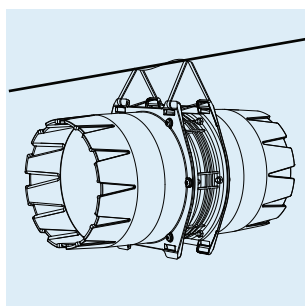

Fan design allows for suspended mounting



Tapered spigots for easy installation and taping



Highly efficient ball bearing EC motor

VA150 FAN

IPX2

220-240V AC
at 50Hz

Includes
flex & plug



AIR MOVEMENT

Order Code	Typical Power	Maximum Airflow	Acoustic Sound Level	Pressure Rating	Duct Size	Price excl. GST
VA150	36W	323m ³ /h 89.7L/s	45.0dB	86Pa	Ø 150mm	\$115.92

Operating Temp (°C)

-20 to 70°C

Mounting

Base Mounted

Material

Housing: Aluminium

Impeller: PBT

Spigots: ABS

FEATURES

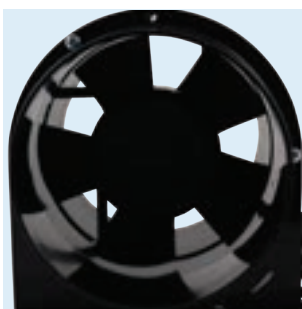

Tapered spigots for easy installation and taping of duct



High quality ball bearing motor

THROUGH WALL FANS

COMING SOON

High performance EC motor

Clip on/off fascia for easy cleaning

AIR MOVEMENT

R&DTM
NZ designed and engineered

Easy installation with integrated wiring termination and short spigot for through wall installation with exterior cowl

Available also in square

Available in white and black

VYNCO

MIXED FLOW IN-LINE FAN KITS

IP44
VAFM1501
Fan

220-240V AC
at 50Hz

Includes
flex & plug

Double
Insulated



Order Code	Typical Power	Maximum Fan Airflow	Duct Size	Duct Length	Price excl. GST	Operating Temp (°C)
VBG4K6M	44W	410m³/h 113L/s	Ø 150mm	6m	\$524.00	-10 to 40°C Refer to individual component pages
	54W	530m³/h 147.2L/s				

Includes a VAFM1501 Fan, White Bond Round Grille, White Reacher Fixed Louvre Grille, Duct, PVC Tape, and Surface Socket.

Mounting

Base Mounted

Material

Refer to individual component pages

FEATURES



Includes magnetic Bond Grille

AXIAL IN-LINE EC FAN KITS



- IP44 VAF16 Fan
- 230-240V AC at 50Hz
- EC Motor
- Double Insulated
- Includes flex & plug



VF16K6BF Pictured.

Order Code	Typical Power	Maximum Fan Airflow	Duct Size	Duct Length	Price excl. GST	Operating Temp (°C)
WHITE BOND ROUND GRILLE KITS						-10 to 70°C
VF16K6BF	20W	410m³/h 114L/s	Ø 150mm	6m	\$239.35	
WHITE REACHER ROUND GRILLE KITS						Suspended / Base Mounted
VF16K6	20W	410m³/h 114L/s	Ø 150mm	6m	\$288.75	
						Mounting
						Material
						Refer to individual component pages

AIR MOVEMENT



FAN KIT WITH GRILLE AND LIGHT

230-240V AC
at 50Hz

Includes
flex & plug

IP44
Fan



VF16K6LF Pictured.

AIR MOVEMENT

Order Code	Typical Power	Maximum Fan Airflow	Duct Size	Duct Length	Price excl. GST	Operating Temp (°C)
VAFM FAN KITS						-10 to 40°C Refer to individual component pages
VF35K6LF	44W	410m³/h 113.9L/s	Ø 150mm	6m	\$449.40	
	54W	530m³/h 147.2L/s				
VAF16 FAN KITS						Mounting
VF16K6LF*	20W	410m³/h 114L/s	Ø 150mm	6m	\$321.38	Suspended / Base Mounted (for VF16K6LF)
VA150 FAN KITS						Base Mounted (for VAK6LF)
VAK6LF	36W	323m³/h 89.7L/s	Ø 150mm	6m	\$253.43	Material
<p>Each kit includes a Fan, White Reacher Round Grille with Light, White Reacher Fixed Louvre Grille, Duct, PVC Tape, and Surface Socket.</p> <p>*VF16K6LF comes with cable ties for suspended mounting.</p>						Refer to individual component pages

AXIAL IN-LINE FAN KITS

IPX2
VA150 Fan

220-240V AC
at 50Hz

Includes
flex & plug



VA150KS Pictured.

Order Code	Typical Power	Maximum Fan Airflow	Duct Size	Duct Length	Price excl. GST	Operating Temp (°C)
WHITE BOND ROUND GRILLE KITS						-10 to 40°C
VBG4K6	36W	323m ³ /h 89.7L/s	Ø 150mm	6m	\$289.24	
*VBG4K6S	36W	323m ³ /h 89.7L/s	Ø 150mm	6m	\$304.66	Mounting Base Mounted
WHITE REACHER ROUND GRILLE KITS						Material Refer to individual component pages
VA150K	36W	323m ³ /h 89.7L/s	Ø 150mm	3m	\$257.29	
VA150K6	36W	323m ³ /h 89.7L/s	Ø 150mm	6m	\$291.55	
*VA150KS	36W	323m ³ /h 89.7L/s	Ø 150mm	3m	\$255.45	
*VA150K6S	36W	323m ³ /h 89.7L/s	Ø 150mm	6m	\$301.31	

Each kit includes a VA150 Fan, a Round Grille and Base, White Reacher Square Fixed Louvre Grille, Duct, and PVC Tape.
*Kit includes a Surface Socket.

FLEXIBLE ALUMINIUM DUCTS

Order Code	Description	Price excl. GST
DCT1003A	3m Ø 100mm	\$20.50
DCT1006A	6m Ø 100mm	\$31.25
DCT1253A	3m Ø 125mm	\$24.30
DCT1256A	6m Ø 125mm	\$55.00
DCT1503A	3m Ø 150mm	\$28.80
DCT1506A	6m Ø 150mm	\$32.40
DCT2003A	3m Ø 200mm	\$25.60
DCT2006A	6m Ø 200mm	\$51.06



DCT1503A

AIR MOVEMENT

ACCESSORIES

Order Code	Description	Price excl. GST
VFT90	Run On Timer, 1-90 mins Fully adjustable fan timer, max. load 500W	\$66.13
88SS1	Single Surface Socket	\$15.91
88SS2	Double Surface Socket	\$24.52



VFT90



88SS1

AIR MOVEMENT

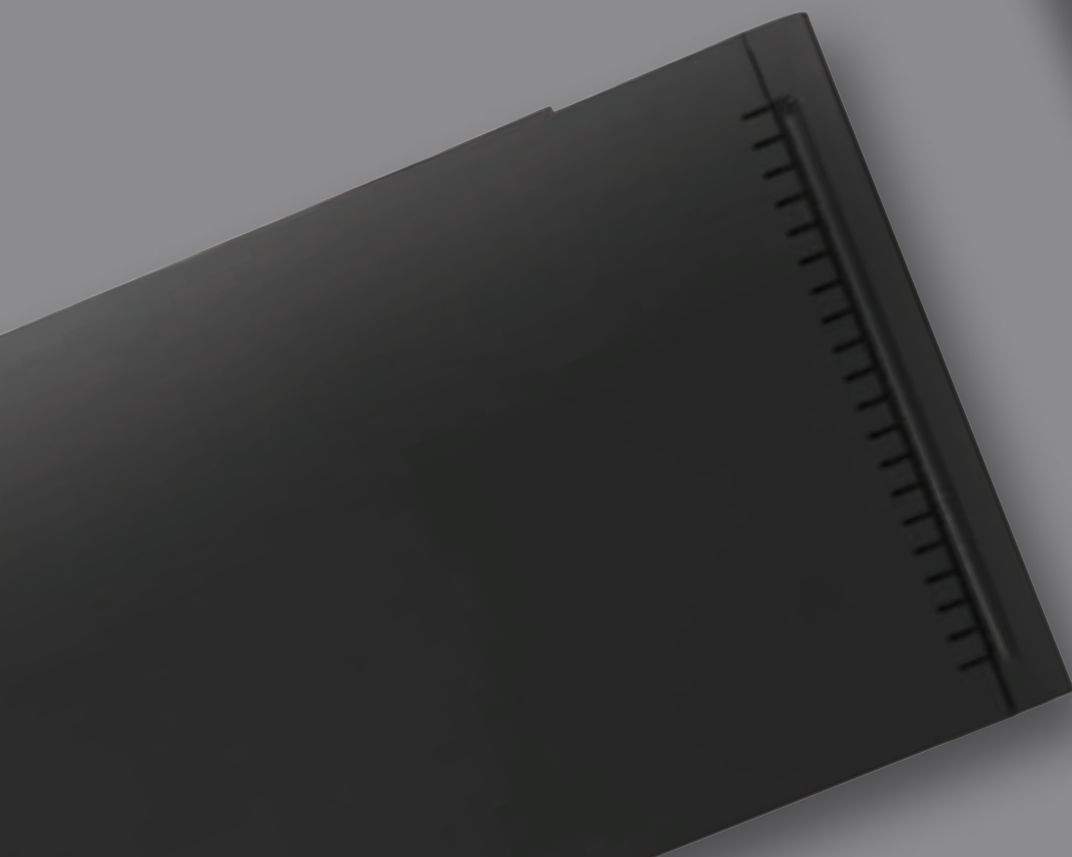

VMC ONE

Our new VMC ONE range combines the best of both worlds, replacing our VM Series shallow and deep combined meterboards with a single board. Housed in a shallow board frame, VMC ONE boards all include a raised clear window, which allows deep single phase meters to be installed. The VMC ONE range will be available in the existing 34 and 51 way options as well as a brand new 17 way option.

NEW



With deep meter window

Electric Vehicle Chargers, Leads, & Accessories	84
VM Series Boards & Accessories	90
V Series Boards & Accessories	99
Flush Distribution Boards	103
Surface Distribution Boards	104
Accessories	106
Splitter Boards	107

E1V2R EV CHARGER

IP55	230V AC	6mA RDC-DD Protection
Single Phase 32A	Use: Indoors Outdoor	Surface Mounted



Order Code	Charging Power	Charging Type	Overall Size (H x W x D)	Price excl. GST
E1V2R	7.4kW	Type 2 Socket	345 x 211 x 122mm	\$1365.00

Operating Temp (°C)
-30 to 55°C
Material
ABS/PC

DISTRIBUTION BOXES

E1V2R EV PILLARS AND MOUNTING KITS



Order Code	Description	Colour	Price excl. GST
EVPS	E1V2R EV Pillar with Mounting Kit	White	\$1149.57
EVPSB	E1V2R EV Pillar with Mounting Kit	Black	\$1149.57



EVPS

FEATURES



Compact, slim body



Rear or bottom wiring



Includes emergency stop



Surface mount

AMTRON - PROFESSIONAL+ E WALLBOX



Order Code	Power Supply	Charging Power	Charging Type	Control	Price excl. GST
1376402	400V AC 50Hz	7.4/22 kW	Type 2 Socket	3G/4G Modem LAN (RJ45) RFID System LED Status	\$3900.00

Operating Temp (°C)
-25 to 40°C
Material
Amelan®

Note: *All Amtron chargers are required to be protected by an RCCB suitable for use with EV charging.

AMTRON PILLARS AND MOUNTING KITS

Order Code	Description	Colour	Price excl. GST
EVPPA	EV Pillar Amtron Mounting Kit	White	\$164.36

Required to be used with the EVPS Pillar (order separately).



EVPPA

BLANK MOUNTING KITS

Order Code	Description	Colour	Price excl. GST
EVPPB	EV Pillar Blank Mounting Kit	White	\$77.89

Required to be used with the EVPS Pillar (order separately).



EVPPB

FEATURES



RFID access for public and semi public areas or multiple charging sites



Read energy consumption directly on your home charging station*



LED operating status display

DISTRIBUTION BOXES

VMEV EV CHARGER

IP41

IK07

230V AC

Single Phase
32A

Indoor
Use Only

Flush Wall
Mounted



Order Code	Colour	Charging Power	Charging Type	Cover Assembly Size (H x W x D)	Price excl. GST	Operating Temp (°C)
VMEV	White	7.4kW	Type 2 Socket	478 x 402 x 35mm	\$1386.00	-30 to 55°C
VMEVB	Black	7.4kW	Type 2 Socket	478 x 402 x 35mm	\$1524.60	

Material

Power Coated Steel / Polycarbonate

DISTRIBUTION BOXES

FEATURES



Matches VM Series



Flush creating slim look



Box Ahead available

VM SERIES BOX AHEAD OPTION 1



Order Code	Description	Colour	Overall Size (H x W)	Price excl. GST
VMEVBT	VMEV Base + Temporary Lid	White	435 x 350 x 77mm	\$118.28
VMEVCU	VMEV Cover + Unit	White	478 x 402 x 125mm	\$1259.84



VMEVBT & VMEVCU

VM SERIES BOX AHEAD OPTION 2



Order Code	Description	Colour	Overall Size (H x W x D)	Price excl. GST
VMEVBC	VMEV Base + Cover	White	478x 402 x 107mm	\$210.93
VMEVU	VMEV Unit	White	356x 310 x 125mm	\$1167.19
VMEVBCB	VMEV Base + Cover	Black	478 x 402 x 107mm	\$232.03
VMEVUB	VMEV Unit	Black	356 x 310 x 125mm	\$1283.91



VMEVBC & VMEVU

DISTRIBUTION BOXES

EV CHARGING CABLES

Order Code	Description	Price excl. GST
36212	Mode 3 Type 2-Type 2 32A 1PH 4m	\$486.54
36213	Mode 3 Type 2-Type 2 32A 3PH 4m	\$602.39
36246	Mode 3 Type 2-Type 2 32A 1PH 7,5m	\$561.84
36247	Mode 3 Type 2-Type 2 32A 3PH 7,5m	\$654.54



36212

DISTRIBUTION BOXES

HOOK

Order Code	Description	Price excl. GST
VMHOOK	VMEV charging cable support hook	\$16.47



VMHOOK

EV CHARGER ACCESSORIES

Order Code	Description	Price excl. GST
AD1NOR15M	Analogue Time Switch 230V AC 16A	\$136.24
ESB4020N06	Contactora 230V AC/DC 2NO 22-40A	\$287.88
952070	Surge Arrestor 1P Class 20kA 275V AC	\$151.32
FH202A40	RCCB 2P Type A 40A 6kA	\$174.31
DSN201EC32A30	Compact RCBO (RCD/MCB) 1P+N Type A 30mA	\$152.81
F202B40003	RCCB 40A 2P Type B 10kA 30mA	\$944.54
F204B40003	RCCB 40A 4P Type B 10kA 30mA	\$1041.29



AD1NOR15M



F202B40003

TESBOX UNIT

Order Code	Description	Price excl. GST
320014	EV Testbox twinlet universal	\$1550.00



320014

CHARGING SOCKETS

Order Code	Description	Power Supply	Charging Power	Control	Price excl. GST
VC3/6C	16A single phase, CEE switched, socket for domestic use	1ph 16A	3.7kW	For use with Mode 2 In-line Chargers	\$227.80



VC3/6C

DISTRIBUTION BOXES

VYNCO

VM SERIES DISTRIBUTION BOARD RANGE

Our in-house research and development team designed the VM series boards in consultation with kiwi electricians to create a matching range of boards to suit the needs of New Zealand's electrical industry.

Vynco is proudly New Zealand owned and operated.

Find out more about the range of Vynco Distribution Boxes, including EV Chargers at VYNCO.CO.NZ

VM SERIES | COMBINED METER BOARDS

Surface Mount Kit fits both the Combined Meter Board and matching Data Board

DISTRIBUTION
BOXES

VMC117



MATCHING
DATA BOARD
VMD540



SURFACE
MOUNT KIT
VM34SK



VMC134



MATCHING
DATA BOARD
VMD



SURFACE
MOUNT KIT
VMCC



TEMPORARY
COVER
VMC1TC



VMC151



MATCHING
DATA BOARD
VMD



SURFACE
MOUNT KIT
VMCC



TEMPORARY
COVER
VMC1TC



VM SERIES | DISTRIBUTION BOARDS

Surface Mount Kit fits both the Distribution Board and matching Data Board



VM17

MATCHING
DATA BOARD
VMD340



SURFACE
MOUNT KIT
VM17SK



VM34

MATCHING
DATA BOARD
VMD540



SURFACE
MOUNT KIT
VM34SK



VM51

MATCHING
DATA BOARD
VMD640



SURFACE
MOUNT KIT
VM51SK



VM68

MATCHING
DATA BOARD
VMD



SURFACE
MOUNT KIT
VMCC



VM85

SURFACE
MOUNT KIT
VM85SK



DISTRIBUTION
BOXES

VM SERIES - VMC ONE

IP40

400V AC

Max Current 100A

Rated Insulation Voltage 1000V



Order Code	Ways	Rows	Colour	Cover Assembly Size (H x W x D)	Base Dimensions (Cut-out Size) (H x W x D)	Meter Space (H x W x D)	Price excl. GST	Material
ONE								
VMC117	17	1	White	477 x 402 x 35mm	445 x 355 x 109mm	275 x 320 x 115mm	\$309.75	Base: Galvanised Steel Cover: Powder Coated Steel End Caps: Polycarbonate
VMC134	34	2	White	800 x 402 x 35mm	754 x 355 x 109mm	275 x 320 x 115mm	\$393.75	
VMC151	51	3	White	800 x 402 x 35mm	754 x 355 x 109mm	275 x 320 x 115mm	\$409.50	
VMC117BK	17	1	Black	477 x 402 x 35mm	445 x 355 x 109mm	275 x 320 x 115mm	POA	
VMC134BK	34	2	Black	800 x 402 x 35mm	754 x 355 x 109mm	275 x 320 x 115mm	POA	
VMC151BK	51	3	Black	800 x 402 x 35mm	754 x 355 x 109mm	275 x 320 x 115mm	POA	

FEATURES



Top or bottom meter mounting

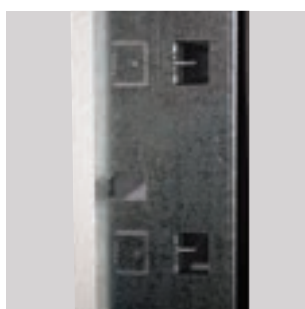

Max meter depth of 115mm depth



The new raised meter window allows deep single phase meters to fit into a shallow board

VM SERIES COMBINED METER BOARDS

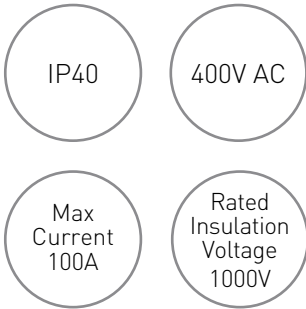

Order Code	Ways	Rows	Colour	Cover Assembly Size (H x W x D)	Base Dimensions (Cut-out Size) (H x W x D)	Meter Space (H x W x D)	Price excl. GST
DEEP							
VMC34DU	34	2	White	1130 x 402 x 77mm	1083 x 355 x 98mm	573 x 320 x 128mm	\$469.32
VMC51DU	51	3	White	1130 x 402 x 77mm	1083 x 355 x 98mm	573 x 320 x 128mm	\$489.43

Material
Base: Galvanised Steel
Cover: Powder Coated Steel
End Caps: Polycarbonate

DISTRIBUTION BOXES

FEATURES Features apply to all VM Series Combined Meter Boards

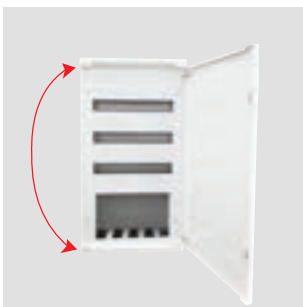

Boards are able to be rotated



DIN rail location stops ensure MCBs line up correctly with cover

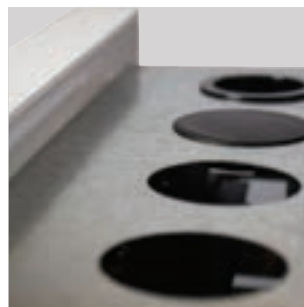

Cable entry holes top and bottom supplied with solid and open caps



Mounting tabs help set the board at the right depth

VM SERIES BOX AHEAD - BASES

Order Code	Description	Overall Size (H x W x D)	Price excl. GST
VMDB	VMD Base	754 x 355 x 106mm	\$100.59
VMC134B	VMC134 Base	754 x 355 x 106mm	\$218.45
VMC151B	VMC151 Base	754 x 355 x 106mm	\$237.29



VMC134B

VM SERIES BOX AHEAD - DOORS & SURROUNDS

Order Code	Description	Overall Size (H x W x D)	Price excl. GST
VMDC	VMD Door, Surround and Parts	800 x 402 x 35mm	\$157.32
VMC134C	VMC134 Door, Surround and Parts	800 x 402 x 35mm	\$179.60
VMC151C	VMC151 Door, Surround and Parts	800 x 402 x 35mm	\$182.77
VMC1TC	Combined meter board temporary cover	748 x 355 x 18.5 mm	\$97.74



VMC134C



VMC1TC

*When using to extend depth of shallow VM Series combined meter board, a VMCB conversion bracket set must be used as well.

VM SERIES BOX AHEAD - INSTALL ACCESSORIES

Order Code	Description	Price excl. GST
VMCB	VM Series Conversion Brackets to Convert Combined Meter Boards from Shallow to Deep	\$31.89

Note: Must be used with a Deep door and surround



VMCB

DISTRIBUTION BOXES

VM SERIES DATA AND COMMUNICATION BOARD

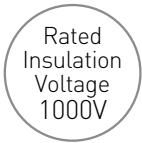

Order Code	Colour	Cover Assembly Size (H x W x D)	Base Dimensions (Cut-out Size) (H x W x D)	Price excl. GST	Material
VMD	White	800 x 402 x 35mm	754 x 355 x 106mm	\$223.30	Base: Galvanised Steel Cover: Powder Coated Steel End Caps: Polycarbonate
VMDBK	Black	800 x 402 x 35mm	754 x 355 x 106mm	\$279.26	
VMD340	White	322 x 402 x 35mm	280 x 355 x 106mm	\$180.79	
VMD540	White	478 x 402 x 35mm	430 x 355 x 106mm	\$230.18	
VMD640	White	628 x 402 x 35mm	580 x 355 x 106mm	\$259.82	
VMDL	White	800 x 402 x 40mm	754 x 355 x 106mm	\$311.63	

Note: VMDL comes with 144 key.

DISTRIBUTION BOXES

FEATURES



Uniform look to pair with VM Series combined meter board



Researched, developed, and manufactured in NZ



Mounting tabs help set the board at the right depth



VMDL lockable version available



VM SERIES DISTRIBUTION BOARDS

IP40

400V AC

Max Current
100A

Rated Insulation Voltage
1000V



Order Code	Ways	Rows	Cover Assembly Size (H x W x D)	Base Dimensions (Cut-out Size) (H x W x D)	Price excl. GST	Material
VM17	17	1	323 x 402 x 35mm	277 x 355 x 106mm	\$187.32	Base: Galvanised Steel Cover: Powder Coated Steel End Caps: Polycarbonate
VM34	34	2	478 x 402 x 35mm	432 x 355 x 106mm	\$281.59	
VM51	51	3	628 x 402 x 35mm	582 x 355 x 106mm	\$330.56	
VM68	68	4	800 x 402 x 35mm	753 x 355 x 106mm	\$416.14	
VM85	85	5	963 x 402 x 35mm	920 x 355 x 106mm	\$535.94	

Note: VM68 matches VMD data board dimensions.

DISTRIBUTION BOXES

FEATURES



DIN rail location stops ensure MCBs line up correctly with cover



Right-hinging or left-hinging rotatable cover



Cable entry holes top and bottom supplied with solid and open caps



Mounting tabs help set the board at the right depth



VM SERIES DISTRIBUTION BOARDS - LOCKABLE

IP40

400V AC

Max Current
100A

Rated Insulation Voltage
1000V



Order Code	Ways	Rows	Cover Assembly Size (H x W x D)	Base Dimensions / Cut-out Size (H x W x D)	Price excl. GST
VM17L	17	1	323 x 402 x 35mm	277 x 355 x 106mm	\$228.31
VM34L	34	2	478 x 402 x 35mm	432 x 355 x 106mm	\$327.06
VM51L	51	3	628 x 402 x 35mm	582 x 355 x 106mm	\$378.37
VM68L	68	4	800 x 402 x 35mm	753 x 355 x 106mm	\$448.91
VM85L	85	5	963 x 402 x 35mm	920 x 355 x 106mm	\$609.24

Material
Base: Galvanised Steel
Cover: Powder Coated Steel
End Caps: Polycarbonate

Note: VM68L matches VMD data board dimensions.
Comes with 144 key.

DISTRIBUTION BOXES

FEATURES



DIN rail location stops ensure MCBs line up correctly with cover



Left-hinging rotatable cover with lock



Cable entry holes top and bottom supplied with solid and open caps



Mounting tabs help set the board at the right depth

VM SERIES ACCESSORIES

Order Code	Description	Overall Size (H x W x D)	Price excl. GST
VM17SK	Surface Mount Kit to Suit VM17 / VM17L / VMD340	341 x 411 x 107mm	\$95.28
VM34SK	Surface Mount Kit to Suit VM34 / VM34L / VMD540 / VMC117	491 x 411 x 107mm	\$109.23
VM51SK	Surface Mount Kit to Suit VM51 / VM51L / VMD640	641 x 411 x 107mm	\$112.29
VM85SK	Surface Mount Kit to Suit VM85 / VM85L	976 x 411 x 107mm	\$236.12
VMCC	VM Series Combined Meter Board Surface Mount Kit to Suit VMD / VMC134 / VMC151	815 x 411 x 107mm	\$154.02



VM34SK



VM51SK

DISTRIBUTION BOXES

V SERIES DISTRIBUTION BOARDS

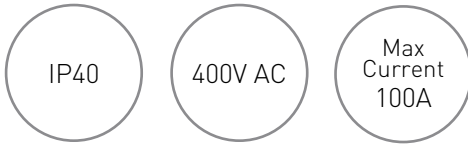

Order Code	Ways	Rows	Cover Assembly Size (H x W x D)	Base Dimensions (H x W x D)	Price excl. GST	Material
V12	12	1	250 x 275 x 25mm	220 x 250 x 66mm	\$136.40	V12 - V40 Door, Sides + Back: PC V60 Door: PC Sides + Back: Steel
V20	20	1	250 x 419 x 22mm	220 x 395 x 66mm	\$177.37	
V30	30	2	400 x 335 x 30mm	372 x 305 x 66mm	\$242.32	
V40	40	2	435 x 420 x 30mm	410 x 395 x 66mm	\$272.92	
V60	60	3	685 x 420 x 30mm	655 x 395 x 66mm	\$480.66	

DISTRIBUTION BOXES

FEATURES



Extra depth behind DIN rail for cable space



Latching doors



Easily removable DIN rails via keyhole



Matching data board and indoor meter board for uniform look

V SERIES BOX AHEAD - BASES

Order Code	Description	Overall Size (H x W x D)	Price excl. GST
V20B	V20 Base and E/N Bars	220 x 395 x 66mm	\$111.74
V30B	V30 Base and E/N Bars	372 x 305 x 66mm	\$152.66
V40B	V40 Base and E/N Bars	412 x 395 x 66mm	\$171.94
V60B	V60 Base and E/N Bars	650 x 390 x 65mm	\$294.56



V40B

V SERIES BOX AHEAD - DOORS & SURROUNDS

Order Code	Description	Overall Size (H x W x D)	Price excl. GST
V12DS	V12 Door, Surround and Parts	250 x 275 x 25mm	\$103.11
V20D	V20 Door, Surround and Parts	250 x 419 x 22mm	\$74.50
V30D	V30 Door, Surround and Parts	400 x 335 x 30mm	\$101.78
V40D	V40 Door, Surround and Parts	435 x 420 x 30mm	\$114.63
V60D	V60 Door, Surround and Parts	685 x 420 x 30mm	\$196.37



V30D

DISTRIBUTION BOXES

V SERIES METER BOARDS

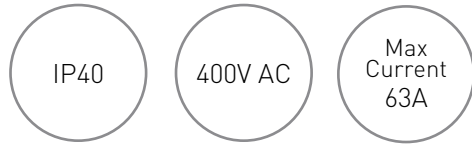

Order Code	Description	Base Dimensions (H x W x D)	Cover Assembly Size (H x W x D)	Meter Space (H x W x D)	Price excl. GST	Material
V40MB	Meter Board Empty	412 x 395 x 66mm	435 x 420 x 30mm	340 x 355 x 74mm	\$217.42	PC
V40MB1	Meter Board with DIN Rail, Earth Stud & 4P Cut-out	412 x 395 x 66mm	435 x 420 x 30mm	340 x 355 x 74mm	\$236.31	

V SERIES COMBINED METER BOARDS



Order Code	Ways	Rows	Base Dimensions (H x W x D)	Surround Dimensions (H x W x D)	Meter Space (H x W x D)	Price excl. GST	Material
V40CMBM	20	1	414 x 396 x 92mm	435 x 420 x 30mm	240 x 350 x 74mm	\$300.02	V40T - V40T135 Door, Surround + Base: PC
V40T	40	2	850 x 400 x 90mm	875 x 420 x 30mm	320 x 380 x 85mm	\$391.93	V40CMBM Door and Surround: PC Base: Galvanised Steel
V40T135*	40	2	850 x 400 x 90mm	875 x 420 x 30mm	320 x 380 x 135mm	\$505.70	

*Includes V40TSPACER

DISTRIBUTION BOXES



V SERIES COMMUNICATION BOARD



Order Code	Description	Base Dimensions (H x W x D)	Price excl. GST	Material
VCC40B	1x Universal Gear Tray 2x 230V AC Socket Outlet	412 x 395 x 66mm	\$438.08	PC
V40DBM	Data board with metal base	414 x 396 x 83mm	\$222.37	

V SERIES ACCESSORIES

Order Code	Description	Overall Dimensions (H x W x D)	Price excl. GST
V40SPACER	Spacer to add 45mm depth to V40 Meter Boards & V40CMBM	447 x 431 x 73mm	\$104.60
V40SPACERDB	DIN Rail Bracket to space out the main incoming breaker. Must be used when using the V40SPACER with V40MB1	-	\$38.64
V40TSPACER	Spacer to add 50mm depth to V40T unit	881 x 431 x 73mm	\$170.53



V40SPACER



V40SPACERDB



V40TSPACER

DISTRIBUTION BOXES

VDF SERIES DISTRIBUTION BOARDS



Order Code	Ways	Rows	Base Box Dimensions (H x W x D)	Door & Surround Dimensions (H x W x D)	Price excl. GST	Material
VDF4	4	1	200 x 115 x 60mm	220 x 135 x 30mm	\$62.19	ABS
VDF8	8	1	200 x 185 x 60mm	220 x 210 x 30mm	\$87.07	
VDF24	24	2	310 x 255 x 65mm	345 x 305 x 30mm	\$206.25	
VDF36	36	3	455 x 293 x 65mm	503 x 341 x 30mm	\$235.01	

DISTRIBUTION BOXES

VSIP SERIES DISTRIBUTION BOARDS



Order Code	Ways	Rows	Base Box Dimensions (H x W x D)	Door & Surround Dimensions (H x W x D)	Price excl. GST	Material
VSIP5	5	1	200 x 125 x 70mm	200 x 125 x 52mm	\$92.58	Body: PS Window: PC
VSIP9	9	1	200 x 200 x 70mm	200 x 200 x 52mm	\$98.36	
VSIP12	12	1	200 x 250 x 70mm	200 x 250 x 52mm	\$162.00	
VSIP24	24	2	370 x 250 x 70mm	370 x 250 x 52mm	\$231.44	
VSIP36	36	3	600 x 300 x 90mm	600 x 300 x 52mm	\$347.16	

ECONOMY RANGE DISTRIBUTION BOARDS



Order Code	Ways	Rows	Base Box Dimensions (H x W x D)	Door & Surround Dimensions (H x W x D)	Price excl. GST	Material
VDS12	12	1	200 x 255 x 40mm	200 x 255 x 55mm	\$110.74	ABS
VDS18	18	1	200 x 362 x 40mm	220 x 362 x 60mm	\$168.88	
VDS24	24	2	325 x 270 x 40mm	325 x 270 x 60mm	\$206.25	
VDS36	36	3	473 x 306 x 40mm	473 x 305 x 65mm	\$283.77	

DISTRIBUTION BOXES

MCB COVERS



Order Code	Ways	Box Dimensions (H x W x D)	Price excl. GST	Material
ME1	1	150 x 23 x 63mm	\$34.52	ABS
ME1W	1	130 x 34 x 60mm	\$22.01	
ME2	2	130 x 51 x 60mm	\$21.70	
ME4	4	130 x 84 x 60mm	\$28.94	
ME6	6	158 x 122 x 64mm	\$45.65	
ME8	8	158 x 157 x 64mm	\$58.52	

DISTRIBUTION BOXES

DISTRIBUTION BOARD ACCESSORIES

Order Code	Description	Price excl. GST
V8013	6 Way, Pole Filler	\$4.02
PB12	12 Way, 63A Phase Bar	\$17.27
PB15	15 Way, 63A Phase Bar	\$20.57
PB18	18 Way, 63A Phase Bar	\$25.32



V8013



PB18

DISTRIBUTION BOXES

ME6 SPLITTER BOARDS



Order Code	Ways	Overall Dimensions (H x W x D)	Price excl. GST
ME6/2	6	158 x 122 x 64mm	\$294.65
ME6/3	6	158 x 122 x 64mm	\$322.95

Material
ABS

*All ME6 splitter boards include E/N bars and phase bar
 ME6/2 splitter boards comes with 1x RCCB; 2 x MCBs (1 x 10A, 1 x 20A)
 ME6/3 splitter boards comes with 1x RCCB; 3 x MCBs (1 x 10A, 2 x 20A)

DISTRIBUTION BOXES

VCP SPLITTER BOARD



Order Code	Ways	Overall Dimensions (H x W x D)	Price excl. GST
VCP4S/2	4	200 x 110 x 94mm	\$173.84

Material
Body: ABS
Lid: PC

*VCP splitter board comes with 1 x main switch, 2 x MCBs (1 x 10A, 1 x 16A)



DSN201E RCBO SERIES

The new DSN201E series is a 1P+N electronic RCBO in one-module width for the protection of end user single-phase circuits against overload and short-circuit currents.

- Compact eRCBO 1P+N in 1M width for DIN rail applications
- Easy installation with supply possible from either end
- Rated current up to 32 A with C tripping characteristics
- 10 kA breaking capacity available up to 20 A
- Busbars available

NEW



Residential/Commercial MCBs	110
Residential/Commercial RCBOs	111
Residential/Commercial RCCBs	113
Isolators	114
Commercial/Industrial MCBs	115
Commercial/Industrial RCBOs	122
Commercial/Industrial RCCBs	125
Arc Fault Detection Devices	127
CMS Devices & Accessories	129
Add-on Devices & Accessories	130
Changeover Switches	132
Surge Protection	133
Time Switches	134
Fuse Links	136
Lockout Kits & Accessories	140

MCBs - 6kA, 1 POLE, C CURVE

230 to
400V ACTerminal
Suits up to
35mm²
wire

Order Code	GE Equivalent	Current Rating	Modules	Price excl. GST
SH201C6	690553	6A	1	\$27.02
SH201C10	690554	10A	1	\$26.28
SH201C16	690555	16A	1	\$26.28
SH201C20	690556	20A	1	\$26.28
SH201C25	690557	25A	1	\$26.28
SH201C32	690558	32A	1	\$26.28
SH201C40	690559	40A	1	\$27.02
SH201C50	690560	50A	1	\$27.85
SH201C63	690561	63A	1	\$27.85

Carton Qty

Box Qty: 12

MCBs - 6kA, 3 POLE, C CURVE

230 to
400V ACTerminal
Suits up to
35mm²
wire

Order Code	GE Equivalent	Current Rating	Modules	Price excl. GST
SH203C6	676179	6A	3	\$148.59
SH203C10	676180	10A	3	\$129.20
SH203C16	676181	16A	3	\$129.20
SH203C20	676182	20A	3	\$129.20
SH203C25	676183	25A	3	\$129.20
SH203C32	676184	32A	3	\$142.13
SH203C40	676185	40A	3	\$155.04
SH203C50	676186	50A	3	\$148.59
SH203C63	676187	63A	3	\$157.63

Carton Qty

Box Qty: 4

COMPACT RCB0s (RCD/MCB) - 1P + N, TYPE A, 10mA

230 to
240V AC

6kA

Switched
Neutral



Order Code	GE Equivalent	Current Rating	Modules	Price excl. GST
DSN201EC6A10	694650	6A	1	\$183.14
DSN201EC10A10	606595, 694651	10A	1	\$183.14
DSN201EC16A10	606596, 694653	16A	1	\$183.14
DSN201EC20A10	606597, 694654	20A	1	\$183.14
DSN201EC25A10	-	25A	1	\$183.14
DSN201EC32A10	694656	32A	1	\$183.14

Carton Qty
Box Qty: 1

COMPACT RCB0s (RCD/MCB) - 1P + N, TYPE A, 30mA

230 to
240V AC

6kA

Switched
Neutral



Order Code	GE Equivalent	Current Rating	Modules	Price excl. GST
DSN201EC6A30	694664	6A	1	\$152.81
DSN201EC10A30	694665	10A	1	\$152.81
DSN201EC16A30	694667	16A	1	\$152.81
DSN201EC20A30	694668	20A	1	\$152.81
DSN201EC25A30	694669	25A	1	\$152.81
DSN201EC32A30	694670	32A	1	\$152.81

Carton Qty
Box Qty: 1

CIRCUIT
PROTECTION

RCB0s (RCD/MCB) - 1P + N, TYPE A, 30mA

230 to
240V AC

6kA

Switched
Neutral



Order Code	GE Equivalent	Current Rating	Modules	Price excl. GST	Carton Qty
DSH201C10A30	690796	10A	2	\$172.08	Box Qty: 6
DSH201C16A30	690797	16A	2	\$172.08	
DSH201C20A30	690798	20A	2	\$172.08	
DSH201C25A30	690799	25A	2	\$175.36	
DSH201C32A30	690800	32A	2	\$172.08	
DSH201C40A30	690801	40A	2	\$172.08	

CIRCUIT
PROTECTION

RCCBs - 6kA, TYPE A, 30mA

230 to
400V AC



Order Code	GE Equivalent	Current Rating	Poles	Modules	Price excl. GST
FH202A40	608403	40A	2	2	\$174.31
FH202A63	608405	63A	2	2	\$208.18
FH204A40	608409	40A	4	4	\$247.34
FH204A63	608411	63A	4	4	\$278.53

Carton Qty
Box Qty: 6

*Except FH204A40 and FH204A63
† Except FH202A40 and FH202A63

RCCBs - 10kA, TYPE B, 30mA

230 to
400V AC

For use with EV Chargers
without Integrated DC
Protection



Order Code	GE Equivalent	Current Rating	Poles	Modules	Price excl. GST
F202B40003	-	40A	2	2	\$944.54
F204B40003	565341	40A	4	4	\$1041.29
F204B63003	565345	63A	4	4	\$1653.81

Carton Qty
Box Qty: 1

CIRCUIT
PROTECTION

RCCB ACCESSORIES

Order Code	Description	Price excl. GST
NL3	Neutral Link for RCCB 3 Way	\$13.89
NL5	Neutral Link for RCCB 5 Way	\$18.69



NL3

ISOLATORS - 63A

400V AC* 10kA



Order Code	GE Equivalent	Current Rating	Modules	Price excl. GST	Carton Qty
SHD20163	666562	63A	1	\$34.88	SHD20163: 12
SHD20263	666563	63A	2	\$69.77	SHD20263: 6
SHD20363	666564	63A	3	\$104.65	SHD20363: 4

Rated conditional short-circuit current 10kA in series with NH 00 ≤ 63 A

*Except SHD20163

CIRCUIT PROTECTION

ISOLATORS - 100A

400V AC* 25kA



Order Code	GE Equivalent	Current Rating	Modules	Price excl. GST	Carton Qty
E201100RD	666558	100A	1	\$67.68	E201100RD: 10
E202100RD	666559	100A	2	\$101.31	E202100RD: 5
E203100RD	666560	100A	3	\$142.33	E203100RD: 3
E204100RD	666561	100A	4	\$214.39	E204100RD: 2

*Except E201100RD = 230V AC

MCBs - 6kA, 1 POLE, C CURVE

230 to
400V AC

72V DC
Max

Double
Terminal
Suits up to
35mm² wire

Accommodates
Accessories



Order Code	GE Equivalent	Current Rating	Modules	Price excl. GST
S201C2	676263	2A	1	\$61.26
S201C4	676265	4A	1	\$61.26
S201C6	676266	6A	1	\$54.11
S201C10	676267	10A	1	\$42.27
S201C16	676269	16A	1	\$42.27
S201C20	676270	20A	1	\$42.27
S201C25	676271	25A	1	\$42.27
S201C32	676272	32A	1	\$42.27
S201C40	676273	40A	1	\$55.74
S201C50	676274	50A	1	\$56.78
S201C63	676275	63A	1	\$55.74

Carton Qty
Box Qty: 12

MCBs - 6kA, 2 POLE, C CURVE

400V AC

125V DC
Max

Double
Terminal
Suits up to
35mm² wire

Accommodates
Accessories



Order Code	GE Equivalent	Current Rating	Modules	Price excl. GST
S202C2	676276	2A	2	\$147.01
S202C4	676278	4A	2	\$147.01
S202C6	676279	6A	2	\$134.76
S202C10	676280	10A	2	\$134.76
S202C16	676282	16A	2	\$134.76
S202C20	676283	20A	2	\$134.76
S202C25	676284	25A	2	\$134.76
S202C32	676285	32A	2	\$134.76
S202C40	676286	40A	2	\$147.01
S202C50	676287	50A	2	\$147.01
S202C63	676288	63A	2	\$147.01

Carton Qty
Box Qty: 6

CIRCUIT PROTECTION

MCBs - 6kA, 3 POLE, C CURVE

400V AC

Double
Terminal
Suits up to
35mm² wire

Accommodates
Accessories



Order Code	GE Equivalent	Current Rating	Modules	Price excl. GST
S203C2	676291	2A	3	\$309.12
S203C4	676293	4A	3	\$306.27
S203C6	676294	6A	3	\$202.13
S203C10	676295	10A	3	\$183.76
S203C16	676297	16A	3	\$183.76
S203C20	676298	20A	3	\$183.76
S203C25	676299	25A	3	\$183.76
S203C32	676300	32A	3	\$183.76
S203C40	676301	40A	3	\$202.13
S203C50	676302	50A	3	\$268.92
S203C63	676303	63A	3	\$278.16
S203C80	-	80A	3	\$587.91
S203C100	-	100A	3	\$552.83

Carton Qty
Box Qty: 4

MCBs - 6kA, 1 POLE, D CURVE

230 to
400V AC

72V DC
Max

Double
Terminal
Suits up to
35mm² wire

Accommodates
Accessories



Order Code	GE Equivalent	Current Rating	Modules	Price excl. GST
S201D2	676306	2A	1	\$134.87
S201D4	676308	4A	1	\$134.87
S201D6	676309	6A	1	\$70.44
S201D10	676310	10A	1	\$70.44
S201D16	676312	16A	1	\$70.44
S201D20	676313	20A	1	\$70.44
S201D25	676314	25A	1	\$70.44
S201D32	676315	32A	1	\$70.44
S201D40	676316	40A	1	\$91.88
S201D50	676317	50A	1	\$91.88
S201D63	676318	63A	1	\$91.88

Carton Qty
Box Qty: 12

CIRCUIT PROTECTION

MCBs - 6kA, 2 POLE, D CURVE

400V AC

125V DC
Max

Double
Terminal
Suits up to
35mm² wire

Accommodates
Accessories



Order Code	GE Equivalent	Current Rating	Modules	Price excl. GST
S202D2	676321	2A	2	\$374.33
S202D4	676323	4A	2	\$374.33
S202D6	676324	6A	2	\$223.17
S202D10	676325	10A	2	\$223.17
S202D16	676327	16A	2	\$223.17
S202D20	676328	20A	2	\$223.17
S202D25	676329	25A	2	\$223.17
S202D32	676330	32A	2	\$223.17
S202D40	676331	40A	2	\$244.40
S202D50	676332	50A	2	\$244.40
S202D63	676333	63A	2	\$244.40

Carton Qty
Box Qty: 6

MCBs - 6kA, 3 POLE, D CURVE

440V AC

Double
Terminal
Suits up to
35mm² wire

Accommodates
Accessories



Order Code	GE Equivalent	Current Rating	Modules	Price excl. GST
S203D2	676336	2A	3	\$428.77
S203D4	676338	4A	3	\$428.77
S203D6	676339	6A	3	\$251.13
S203D10	676340	10A	3	\$251.13
S203D16	676342	16A	3	\$251.13
S203D20	676343	20A	3	\$251.13
S203D25	676344	25A	3	\$251.13
S203D32	676345	32A	3	\$251.13
S203D40	676346	40A	3	\$300.14
S203D50	676347	50A	3	\$300.14
S203D63	676348	63A	3	\$300.14

Carton Qty
Box Qty: 4

CIRCUIT PROTECTION

MCBs - 10kA, 1 POLE, C CURVE

230 to
400V AC

72V DC
Max

Double
Terminal
Suits up to
35mm² wire

Accommodates
Accessories



Order Code	GE Equivalent	Current Rating	Modules	Price excl. GST
S201MC4	674858	4A	1	\$79.63
S201MC6	674859	6A	1	\$58.19
S201MC10	674861	10A	1	\$58.19
S201MC16	674863	16A	1	\$58.19
S201MC20	674864	20A	1	\$58.19
S201MC25	674865	25A	1	\$58.19
S201MC32	674866	32A	1	\$58.19
S201MC40	674867	40A	1	\$58.19
S201MC50	674868	50A	1	\$97.94
S201MC63	674869	63A	1	\$97.94
S801BC80	671528	80A	1	\$209.40
S801BC100	671529	100A	1	\$226.64
S801BC125	671530	125A	1	\$263.38

Carton Qty

Box Qty: 12
Except S801BC80, S801BC100,
& S801BC125: 1

MCBs - 10kA, 2 POLE, C CURVE

400V AC

125V DC
Max

Double
Terminal
Suits up to
35mm² wire

Accommodates
Accessories



Order Code	GE Equivalent	Current Rating	Modules	Price excl. GST
S202MC0.5	674886	0.5A	2	\$606.40
S202MC1	674887	1A	2	\$606.40
S202MC2	674888	2A	2	\$205.86
S202MC4	674890	4A	2	\$205.86
S202MC6	674891	6A	2	\$202.30
S202MC10	674893	10A	2	\$202.30
S202MC16	674895	16A	2	\$202.30
S202MC20	674896	20A	2	\$202.30
S202MC25	674897	25A	2	\$202.30
S202MC32	674898	32A	2	\$202.30
S202MC40	674899	40A	2	\$202.30
S202MC50	674900	50A	2	\$257.26
S202MC63	674901	63A	2	\$257.26
S802BC80	671534	80A	2	\$462.83
S802BC100	671535	100A	2	\$464.08
S802BC125	671536	125A	2	\$606.40

Carton Qty

Box Qty: 6
Except S802BC80, S802BC100,
& S802BC125: 1

CIRCUIT PROTECTION

MCBs - 10kA, 3 POLE, C CURVE

400V AC

Double Terminal Suits up to 35mm² wire

Accommodates Accessories



Order Code	GE Equivalent	Current Rating	Modules	Price excl. GST
S203MC4	674906	4A	3	\$306.27
S203MC6	674907	6A	3	\$232.76
S203MC10	674909	10A	3	\$232.76
S203MC16	674911	16A	3	\$232.76
S203MC20	674912	20A	3	\$232.76
S203MC25	674913	25A	3	\$232.76
S203MC32	674914	32A	3	\$232.76
S203MC40	674915	40A	3	\$232.76
S203MC50	674916	50A	3	\$336.89
S203MC63	674917	63A	3	\$336.89
S803BC80	671540	80A	3	\$583.90
S803BC100	671541	100A	3	\$583.90

Carton Qty
Box Qty: 4
Except S803BC80, S803BC100, & S803BC125: 1

MCBs - 10kA, 1 POLE, D CURVE

230 to 400V AC

72V DC Max

Double Terminal Suits up to 35mm² wire

Accommodates Accessories



Order Code	GE Equivalent	Current Rating	Modules	Price excl. GST
S201MD4	675020	4A	1	\$228.41
S201MD6	675021	6A	1	\$161.09
S201MD10	675023	10A	1	\$134.64
S201MD16	675025	16A	1	\$134.64
S201MD20	675026	20A	1	\$153.88
S201MD25	675027	25A	1	\$161.09
S201MD32	675028	32A	1	\$157.48
S201MD40	675029	40A	1	\$174.31
S201MD50	675030	50A	1	\$224.40
S201MD63	675031	63A	1	\$256.46

Carton Qty
Box Qty: 12

CIRCUIT PROTECTION

MCBs - 10kA, 2 POLE, D CURVE

400V AC

125V DC
Max

Double
Terminal
Suits up to
35mm² wire

Accommodates
Accessories



Order Code	GE Equivalent	Current Rating	Modules	Price excl. GST
S202MD0.5	675048	0.5A	2	\$524.59
S202MD1	675049	1A	2	\$524.59
S202MD2	675050	2A	2	\$524.59
S202MD4	675052	4A	2	\$524.59
S202MD6	675053	6A	2	\$368.37
S202MD10	675055	10A	2	\$336.89
S202MD16	675057	16A	2	\$336.89
S202MD20	675058	20A	2	\$352.63
S202MD25	675059	25A	2	\$368.37
S202MD32	675060	32A	2	\$384.12
S202MD40	675061	40A	2	\$422.18
S202MD50	675062	50A	2	\$461.62
S202MD63	675063	63A	2	\$524.59
S802BD125	671560	125A	2	\$638.00

Carton Qty
Box Qty: 6
Except S802BD125: 1

MCBs - 10kA, 3 POLE, D CURVE

400V AC

Double
Terminal
Suits up to
35mm² wire

Accommodates
Accessories



Order Code	GE Equivalent	Current Rating	Modules	Price excl. GST
S203MD4	675068	4A	3	\$728.91
S203MD6	675069	6A	3	\$551.27
S203MD10	675071	10A	3	\$361.39
S203MD16	675073	16A	3	\$361.39
S203MD20	675074	20A	3	\$361.39
S203MD25	675075	25A	3	\$361.39
S203MD32	675076	32A	3	\$361.39
S203MD40	675077	40A	3	\$361.39
S203MD50	675078	50A	3	\$728.91
S203MD63	675079	63A	3	\$728.91
S803BD80	671564	80A	3	\$762.96
S803BD100	671565	100A	3	\$851.41
S803BD125	671566	125A	3	\$918.79

Carton Qty
Box Qty: 4
Except S803BD80, S803BD100, S803BD125: 1

CIRCUIT PROTECTION

MCBs - 25kA, 1 POLE, C CURVE

- 230 to
400V AC
- 72V DC
Max
- Double
Terminal
Suits up to
35mm² wire
- Accommodates
Accessories



Order Code	GE Equivalent	Current Rating	Modules	Price excl. GST	Carton Qty
S201PC10	675291	10A	1	\$146.10	Box Qty: 12
S201PC20	675294	20A	1	\$167.42	

MCBs - 25kA, 3 POLE, C CURVE

- 400V AC
- Double
Terminal
Suits up to
35mm² wire
- Accommodates
Accessories



Order Code	GE Equivalent	Current Rating	Modules	Price excl. GST	Carton Qty
S203PC63	675331	63A	3	\$1017.75	Box Qty: 4

CIRCUIT PROTECTION

COMPACT RCBOs (RCD/MCB) - 1P+N, TYPE A, 10mA: CHASSIS AND BUSBAR CONNECTION

230V AC

6kA

Switched
Neutral



Order Code	GE Equivalent	Current Rating	Modules	Price excl. GST	Carton Qty
DSE201C10A10NS	694853,694841	10A	1	\$272.54	Box Qty: 1
DSE201C16A10NS	694854,694842	16A	1	\$272.54	
DSE201C20A10NS	694855,694843	20A	1	\$272.54	

Residual current operated circuit breaker with overcurrent protection.
Compact chassis or DIN mount / phase bar connectible.

CIRCUIT PROTECTION

COMPACT RCBOs (RCD/MCB) - 1P+N, TYPE A, 30mA: CHASSIS AND BUSBAR CONNECTION

230V AC

6kA

Switched
Neutral



Order Code	GE Equivalent	Current Rating	Modules	Price excl. GST	Carton Qty
DSE201C6A30NS	694810	6A	1	\$235.22	Box Qty: 1
DSE201C10A30NS	694811	10A	1	\$235.22	
DSE201C16A30NS	694812	16A	1	\$235.22	
DSE201C20A30NS	694813	20A	1	\$235.22	
DSE201C25A30NS	694814	25A	1	\$235.22	
DSE201C32A30NS	694815	32A	1	\$235.22	

Residual current operated circuit breaker with overcurrent protection.
Compact chassis or DIN mount / phase bar connectible.

RCBOs (RCD/MCB) - 1P+N, TYPE A, 10mA

230 to
400V AC

10kA

Switched
Neutral



Order Code	GE Equivalent	Current Rating	Modules	Price excl. GST	Carton Qty
DS201MC10A10	604997	10A	2	\$398.14	Box Qty: 1
DS201MC16A10	604998	16A	2	\$398.14	

RCBOs (RCD/MCB) - 1P+N, TYPE A, 30mA

230 to
400V AC

10kA

Switched
Neutral



Order Code	GE Equivalent	Current Rating	Modules	Price excl. GST	Carton Qty
DS201MC10A30	609901	10A	2	\$361.39	Box Qty: 1
DS201MC16A30	609903	16A	2	\$361.39	
DS201MC20A30	609904	20A	2	\$361.39	
DS201MC25A30	609905	25A	2	\$361.42	
DS201MC32A30	609906	32A	2	\$361.39	
DS201MC40A30	609907	40A	2	\$361.39	

CIRCUIT PROTECTION

RCBOs (RCD/MCB) - 3P+N, TYPE A, 30mA

400 to
415V AC

6kA

Switched
Neutral



Order Code	Current Rating	Modules	Price excl. GST	Carton Qty
DS203NCC6A30	6A	4	\$1177.54	Box Qty: 1
DS203NCC10A30	10A	4	\$1177.54	
DS203NCC16A30	16A	4	\$1177.54	
DS203NCC20A30	20A	4	\$1177.54	
DS203NCC25A30	25A	4	\$1177.54	
DS203NCC32A30	32A	4	\$1177.54	

CIRCUIT PROTECTION

RCCBs - 10kA, TYPE A, 30mA

230 to
400V AC



Order Code	GE Equivalent	Current Rating	Poles	Modules	Price excl. GST
F202A40003	606087	40A	2	2	\$248.40
F202A63003	606088	63A	2	2	\$497.85
F204A25003	606163	25A	4	4	\$317.29
F204A40003	607394	40A	4	4	\$317.29
F204A63003	606165	63A	4	4	\$356.49
F204A100003	606167	100A	4	4	\$1082.16

Carton Qty
Box Qty: 1

RCCBs - 10kA, TYPE A, 300mA

400V AC



Order Code	GE Equivalent	Current Rating	Poles	Modules	Price excl. GST
F204A4003	606179	40A	4	4	\$546.49
F204A6303	607401	63A	4	4	\$672.03

Carton Qty
Box Qty: 1

CIRCUIT
PROTECTION

RCCBs - 10kA, TYPE B, 30mA

230 to
400V AC

Torque
Setting
2.8Nm

Suitable for EV Chargers
without Integrated DC
Protection



Order Code	GE Equivalent	Current Rating	Poles	Modules	Price excl. GST	Carton Qty
F202B40003	-	40A	2	2	\$944.54	Box Qty: 1
F204B40003	565341	40A	4	4	\$1041.29	
F204B63003	565345	63A	4	4	\$1653.81	

CIRCUIT PROTECTION

RCCBs - HIGH IMMUNITY, 30mA

230V AC

Torque
Setting
2.8Nm

10kA



Order Code	GE Equivalent	Current Rating	Poles	Modules	Type	Price excl. GST	Carton Qty
F202A40APR	607095	40A	2	2	Type A, Instantaneous (APR High Immunity)	\$652.92	Box Qty: 1

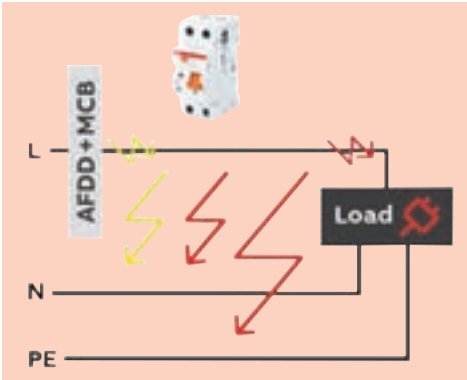

AFDD with integrated MCB includes protection against overcurrent

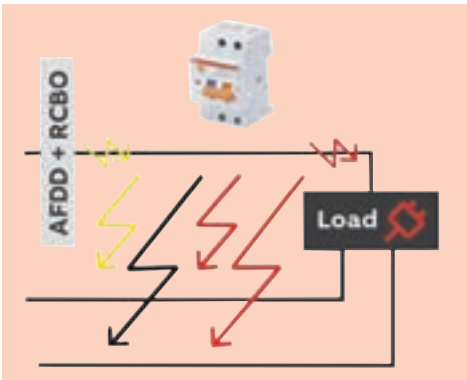

AFDD with integrated RCBO includes protection against overcurrent and current leakage to earth



Reduces downtime with easy troubleshooting via LED monitoring

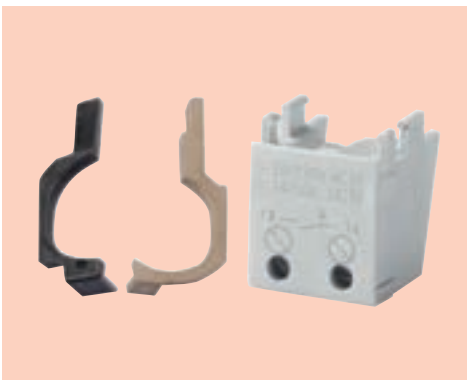

Compatible with System Pro M Compact® Accessories



ARC FAULT DETECTION DEVICES

Reduce the risk of fire by using Arc Fault Detection Devices (AFDD) to protect against earth arc faults, parallel arc faults, and series arc faults.

Recommended for:

- Home and Daycare Centres
- Retirement Homes
- Hotels
- Hospitals
- Gas Stations
- Skyscrapers
- Museums
- R&D Centres and Laboratories

CIRCUIT PROTECTION

AFDD WITH INTEGRATED MCB, C CURVE

230V AC

Overcurrent Protection

6kA



NEW

Order Code	Current Rating	Poles	Modules	Price excl. GST
SARC1C6	6A	1 + N	2	\$277.34
SARC1C10	10A	1 + N	2	\$277.34
SARC1C16	16A	1 + N	2	\$277.34
SARC1C20	20A	1 + N	2	\$277.34

Carton Qty
Box Qty: 1

CIRCUIT PROTECTION

AFDD WITH INTEGRATED RCBO - TYPE A, 30mA

230V AC

Overcurrent Protection

Earth Leakage Protection

6kA



NEW

Order Code	Current Rating	Poles	Modules	Price excl. GST
DSARC1C6A30	6A	1 + N	3	\$379.67
DSARC1C10A30	10A	1 + N	3	\$361.60
DSARC1C16A30	16A	1 + N	3	\$361.60
DSARC1C20A30	20A	1 + N	3	\$361.60

Carton Qty
Box Qty: 1

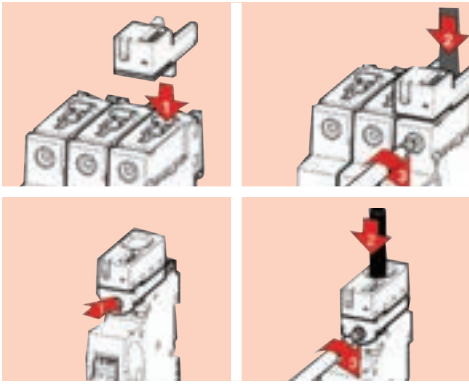

Easy MCB-mount sensors saves up to 30% of installation time



Easy retrofit and upgrade

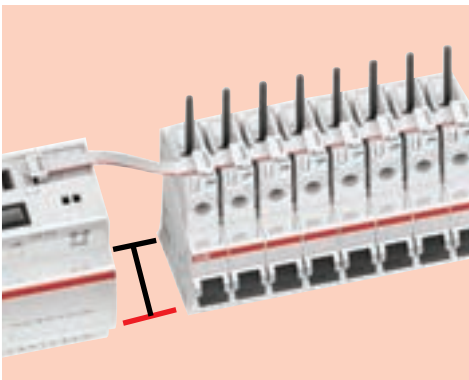

Minimum space requirements due to ultra-compact sensors

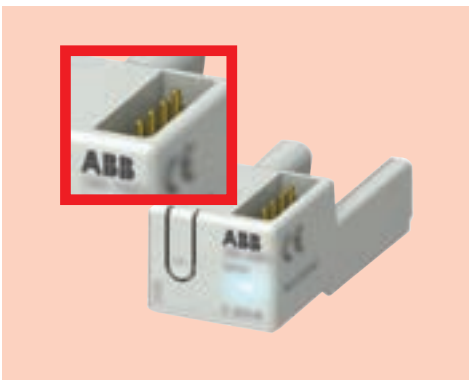

One sensor for all currents DC, AC, or mixed (up to 160A)



CIRCUIT MONITORING SYSTEM

The CMS is an ultra-compact and high-performance multichannel measurement system for AC and DC branch monitoring.

It is a complete solution for monitoring electrical parameters in distribution panels, enabling power monitoring and energy efficiency analysis in buildings and critical power applications.

SIGNAL / AUXILIARY CONTACTS

Order Code	Description	Contact Configuration	Price excl. GST
S2CH6R	Right Side Mount Auxiliary Contact Suits S200, F200, DS201, DS202C, SD200, DSE201M, S-ARC, DSRC	1 CO	\$88.20
S2CSH6R	Side Mount Auxiliary/Signal Contact Suits S200, F200, DS201, DS202C, DSE201M, SD200	1 CO	POA
S2CH01	Bottom Mount Auxiliary Contact Suits S200, DSE201M, DS-ARC	1 NC	POA
S2CH10	Bottom Mount Auxiliary Contact Suits S200, DSE201M, DS-ARC	1 NO	POA



S2CH6R



S2CSH6R



S2CH01



S2CH10

BUSBAR ACCESSORIES

Order Code	Description	Contact Configuration	Price excl. GST
S803BB250	Busbar Insulated Suits S803 3P 24 Way 250A	N/A	\$866.19
S800END	Busbar Endcap Suits S803BB250	N/A	\$58.92
S803BBPC120	Busbar Feedblock Suits S803BBPC120 3P 120MM ²	N/A	\$293.98

INSULATED BUSBAR (WITH CIRCUIT INDICATOR)

Order Code	Type	Style	Size	Amps End Fed	Amps Centre Fed	Ways	Price excl. GST
PS160	1P	PS1	10mm ²	63A	80A	60 Way	\$159.06
PS16016	1P	PS1	16mm ²	80A	130A	60 Way	\$173.10
PS258	2P	PS2	10mm ²	63A	80A	58 Way	\$264.97
PS25816	2P	PS2	16mm ²	80A	130A	58 Way	\$386.90
PS312	3P	PS3	10mm ²	63A	80A	12 Way	\$85.79
PS31216	3P	PS3	16mm ²	80A	130A	12 Way	\$141.98
PS360	3P	PS3	10mm ²	63A	80A	60 Way	\$461.62
PS36016	3P	PS3	16mm ²	80A	130A	60 Way	\$540.39



CIRCUIT PROTECTION

LATCHING RELAYS

230V AC

16kA

16A



Order Code	Contact Configuration	Price excl. GST
E2901610230	1NO	\$140.63
E2901620230	2NO	\$152.84

Carton Qty
Box Qty: 10

TIME RELAY MULTIFUNCTION

12-240V
AC/DC

0.05s to
100hrs

5A



Order Code	Timing Functions	Contact Configuration	Price excl. GST
CTMFD21	7	2C/O	\$587.74

Carton Qty
Box Qty: 1

Timing Functions - ON delay/OFF delay, impulse ON, impulse OFF
- Flasher starting ON, flasher starting OFF, pulse former

CIRCUIT PROTECTION

BELL TRANSFORMERS

230V
Input

24V/15VA
Output

12V/7.5VA
Output



Order Code	GE Equivalent	Power Supply	Price excl. GST
TM1524	665901	15VA	\$133.56

Carton Qty
Box Qty: 6

CHANGEOVER SWITCHES

250V AC 3kA



Order Code	GE Equivalent	Current Rating	Contact Configuration	Price excl. GST
E21316001	666586	16A	1CO	\$132.21
E21416101	666606	16A	1CO I-0-II	\$161.87
E21425202	666609	25A	2CO I-0-II	\$271.10

Carton Qty
Box Qty: 10

CONTACTORS

AC/DC Type

Order Code	GE Equivalent	AC-1	AC-3	Contact Configuration	Control Circuit	Modules	Price excl. GST
ESB2011N01	666127	20A	9A	1NO 1NC	24V	1	\$116.38
ESB2020N01	666133	20A	9A	2NO	24V	1	\$121.28
ESB2011N06	666126	20A	9A	1NO 1NC	230V	1	\$116.38
ESB2020N06	666131	20A	9A	2NO	230V	1	\$104.86
ESB2002N06	666128	20A	9A	2NC	230V	1	\$143.95
ESB2540N06	666142	25A	9A	4NO	230V	2	\$165.38
ESB2504N06	666139	25A	9A	4NC	230V	3	\$172.48
ESB4020N06	666146	40A	22A	2NO	230V	3	\$287.88
ESB4040N06	666151	40A	22A	4NO	230V	3	\$370.57
ESB6340N06	666156	63A	30A	4NO	230V	3	\$471.65



ESB2020N01



ESB2540N06



ESB4040N06



ESB630N06

AC1: Non-inductive or slightly inductive AC loads e.g. heaters or resistive loads
 AC3: Inductive AC loads, e.g. motors

CIRCUIT PROTECTION

SURGE ARRESTORS - DEHN GUARD

Pluggable, single-pole surge arrester consisting of a base part and a plug-in protection module.



Order Code	Poles	Class	Maximum Discharge Current kA (8/20µs)	Maximum Continuous Voltage (Uc)	Cat Ref	Remote Signaling Contact	Module	Price excl. GST	Carton Qty
952070	1	2	40kA	275V	DG S 275		1	\$158.89	Box Qty: 1
952090	1	2	40kA	275V	DG S 275 FM	✓	1	\$333.70	

SURGE ARRESTORS - COMMERCIAL/INDUSTRIAL



Order Code	Poles	Class	Discharge Current kA (8/20µs)	Maximum Continuous Voltage (Uc)	Cat Ref	Remote Signaling Contact	Module	Price excl. GST	Carton Qty
952315	3 + 1	2	Max 40kA	275V	DG M TT 275 FM	✓	4	\$1275.90	Box Qty: 1
952305	3	2	Max 40kA	275V	DG M TNC 275 FM	✓	3	\$929.12	
953205	2	3	Total 5kA	255V	DR M 2P 255 FM	✓	1	\$386.35	
941305	3	2	Nominal 12.5 / 37.5kA	255V	DSH TNC 255 FM	✓	4	\$1843.96	
952330	3	2	Nominal 20kA	275V	DG M TNC ACI 275 FM	✓	3	\$1387.13	
941310	3+1	1+2	125kA	255V	DSH TT 255		4	\$2257.36	
952341	3+1	2	120kA	275V	DGM TT ACI 275 FM	✓	4	\$1673.67	

CIRCUIT PROTECTION

REPLACEMENT MODULE



Order Code	Description	Cat Ref	Price excl. GST	Carton Qty
952010	Protection module for 952070, 952090, 952305, 953205 and 952315	DG MOD 275	\$229.01	Box Qty: 1



Use with ABB Digital Timers.

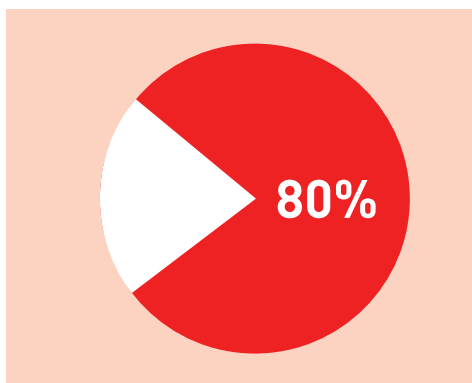
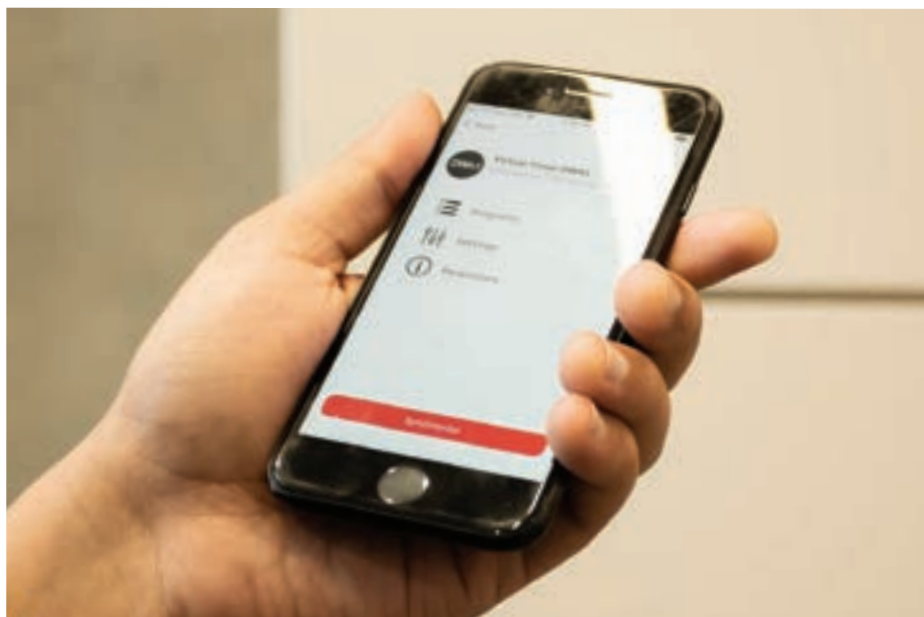

Save up to 80% of commissioning time.



EASY PROGRAMMING WITH THE ABB DBT TIMER APP

Use the DBT Timer app to create new programs, manually control the relay output(s), activate the random and cyclic function, view parameters, and transfer programs from one device to another.

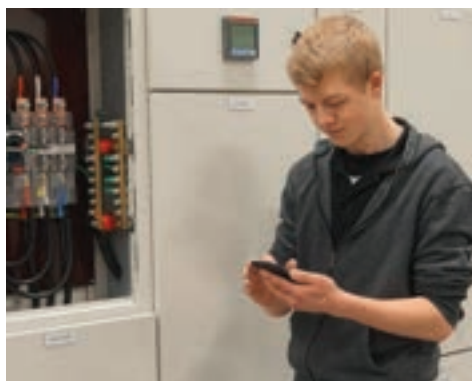

Update programming remotely.



Download the **DBT Timer** app via the Apple Store or Google Play.

CIRCUIT PROTECTION

ANALOGUE TIME SWITCHES

230V AC 16A



Order Code	Program	Channel	Reserve	Shortest Switch Time	Modules	Price excl. GST
AD1NOR15M	Daily	1	100hrs	15 mins	1	\$136.24
AD1COR15M	Daily	1	150hrs	15mins	2	\$194.63
AD1R15M72	Weekly	1	100hrs	15 mins	4 (DIN & Panel Mount)	\$148.84

Carton Qty
Box Qty: 1

DIGITAL TIME SWITCHES

230V AC Bluetooth Interface DBT Timer App Programmable 16A



Order Code	Program	Channel	Reserve	Time App	Modules	Price excl. GST
DW1	Weekly	1	6 Years	Yes	2	\$228.98
DW2	Weekly	2	6 Years	Yes	2	\$332.02
DY365	Yearly	2	6 Years	Yes	4	\$681.22

Carton Qty
Box Qty: 1

CIRCUIT PROTECTION

TIME SWITCH & LIGHT SENSOR

230V AC 16A 2 to 200 Lux



Order Code	Contact Configuration	Modules	Price excl. GST
TL1	1 NO	1	\$286.23

Carton Qty
Box Qty: 1

NS STAGGERED CONTACT FUSE LINKS

80kA
breaking
capacity at
415V AC

Fits 32A
clip-in fuse
carriers



Order Code	Current Rating (Normal)	Current Rating (Motor)	Price excl. GST
NS2	2A	N/A	\$8.68
NS4	4A	N/A	\$8.68
NS6	6A	N/A	\$8.68
NS10	10A	N/A	\$8.68
NS16	16A	N/A	\$8.68
NS20	20A	N/A	\$8.68
NS25	25A	N/A	\$9.19
NS32	32A	N/A	\$9.19
NS10M16	10A	16A	\$12.08
NS16M20	16A	20A	\$12.08
NS20M25	20A	25A	\$12.08
NS20M32	20A	32A	\$12.08
NS32M40	32A	40A	\$13.17

Carton Qty
Box Qty: 25 Except NS32M40: 20

ES STAGGERED CONTACT FUSE LINKS

80kA
breaking
capacity at
415V AC

Fits 63A
clip-in fuse
carriers



Order Code	Current Rating (Normal)	Length	Diameter	Price excl. GST
ES32	32A	68mm	Ø 17mm	\$29.81
ES40	40A	68mm	Ø 17mm	\$29.81
ES50	50A	68mm	Ø 17mm	\$29.81
ES63	63A	68mm	Ø 17mm	\$29.81

Carton Qty
Box Qty: 20

OFFSET BOLTED CONTACT FUSE LINKS (415V)

80kA
breaking
capacity at
500V AC



Order Code	Current Rating (Normal)	Current Rating (Motor)	Fixing Centres	Price excl. GST
NIT4	4A	N/A	44.5mm	\$14.49
NIT10	10A	N/A	44.5mm	\$14.49
NIT20	20A	N/A	44.5mm	\$17.41

Carton Qty

Box Qty: 25

OFFSET BOLTED CONTACT FUSE LINKS (500V)

80kA
breaking
capacity at
500V AC



Order Code	Current Rating (Normal)	Current Rating (Motor)	Fixing Centres	Price excl. GST
TIA10	10A	N/A	73mm	\$16.64
TIA16	16A	N/A	73mm	\$16.64
TIA20	20A	N/A	73mm	\$16.64
TIA25	25A	N/A	73mm	\$16.64
TIA32	32A	N/A	73mm	\$16.64
TIA32M40L	32A	40A	73mm	\$20.24
TIA32M63	32A	63A	73mm	\$20.24
TIS40	40A	N/A	73mm	\$20.37
TIS50	50A	N/A	73mm	\$20.37
TIS63	63A	N/A	73mm	\$20.37
TIS63M80	63A	80A	73mm	\$29.04
TIS63M100	63A	100A	73mm	\$31.86
TCP40A	40A	N/A	94mm	\$35.02
TCP63A	63A	N/A	94mm	\$38.62
TCP80	80A	N/A	94mm	\$49.16
TCP100	100A	N/A	94mm	\$49.16
TCP100M125	100A	125A	94mm	\$59.57
TCP100M160	100A	160A	94mm	\$59.57

Carton Qty

Box Qty: 10

Except TIA25, TIA32, TIS40, TIS50, and TIS63: 6

Except TIS63M80 and TIS63M100: 20

FERRULE CAPS

GB13539
Compliant

IEC269
Compliant



Order Code	Current Rating (Normal)	Length	Diameter	Price excl. GST
LC FERRULE CAP				
3010LC	10A	25mm	Ø 6.3mm	\$15.80
15LC	15A	25.8mm	Ø 10.3mm	\$15.80
3016LC	16A	29mm	Ø 12.7mm	\$17.46
3020LC	20A	29mm	Ø 12.7mm	\$17.46
30LC	30A	29mm	Ø 12.7mm	\$17.46
R FERRULE CAP				
154R	15A	58mm	Ø 22.2mm	\$16.38
204R	20A	58mm	Ø 22.2mm	\$16.38
304R	30A	58mm	Ø 22.2mm	\$16.38
404R	40A	58mm	Ø 22.2mm	\$16.38
504R	50A	58mm	Ø 22.2mm	\$18.31
604R	60A	58mm	Ø 22.2mm	\$18.31
804R	80A	58mm	Ø 22.2mm	\$21.34
1004R	100A	58mm	Ø 22.2mm	\$21.34

Carton Qty

Box Qty: 10

Except 3016LC, 3020LC,
and 30LC: 20

DIN/BLADE FUSE LINKS

Not motor rated.



Order Code	Current Rating	Length	Price excl. GST
SIZE 000 or 00C			
NHG000/006	6A	78mm	\$28.08
NHG000/010	10A	78mm	\$28.08
NHG000/020	20A	78mm	\$28.08
NHG000/025	25A	78mm	\$28.08
NHG000/032	32A	78mm	\$28.08
NHG000/035	35A	78mm	\$28.08
NHG000/040	40A	78mm	\$28.08
NHG000/050	50A	78mm	\$28.08
NHG000/063	63A	78mm	\$28.08
NHG000/080	80A	78mm	\$28.08
NHG000/100	100A	78mm	\$28.08
NHG000/125	125A	78mm	\$28.08
NHG000/160	160A	78mm	\$33.74
SIZE 1			
NHG1/035	35A	135mm	\$43.58
NHG1/063	63A	135mm	\$68.70
NHG1/100	100A	135mm	\$64.85
NHG1/160	160A	135mm	\$58.34
NHG1/200	200A	135mm	\$60.02
NHG1/250	250A	135mm	\$60.02
SIZE 2			
NHG2/063	63A	150mm	\$89.45
NHG2/100	100A	150mm	\$89.45
NHG2/125	125A	150mm	\$89.45
NHG2/160	160A	150mm	\$89.45
NHG2/200	200A	150mm	\$89.45
NHG2/250	250A	150mm	\$89.45
NHG2/315	315A	150mm	\$89.45
NHG2/400	400A	150mm	\$89.45
SIZE 3			
NHG3/315	315A	150mm	\$124.59
NHG3/400	400A	150mm	\$134.41
NHG3/500	500A	150mm	\$205.87
NHG3/630	630A	150mm	\$214.66

Carton Qty

Box Qty: 3

CIRCUIT PROTECTION

LOCKOUT KITS & LOCKS

Order Code	Description	Padlock Colour	Price excl. GST
KITS			
VYNCOSAFETYKIT	1x 25mm & 1x 38mm Insulated Lockout Hasp 1x Long Shackle Padlock (Yellow) 1x Short Shackle Padlock (Red) 1x 5 pack MCB lockouts 2x of each Lockout Tag	Yellow/Red	\$267.35
MCBLOCKOUTPACK	5 x MCB Lockouts plus Padlock	Red & White	\$159.87
PADLOCKS			
VLOSSY	Short Shackle, Steel	Yellow	\$31.58
VLOSSR	Short Shackle, Steel	Red	\$36.21
VLOSSRYA	Keyed Alike Short Shackle, Steel	Yellow	\$36.21
VLOSSRA	Keyed Alike Short Shackle, Steel	Red	\$36.21
VLOSSBA	Keyed Alike Short Shackle, Steel	Blue	\$36.21
VLOLSY	Long Shackle, Steel	Yellow	\$40.23
VLOLSR	Long Shackle, Steel	Red	\$40.23
VLOLSB	Long Shackle, Steel	Blue	\$40.23
VLOLSW	Long Shackle, Steel	White	\$40.23
LM-ULP-SS-Y-S	Short Shackle with Plastic Surround to Protect Against Possible Shock	Yellow	\$44.27
LM-ULP-SS-R-S	Short Shackle with Plastic Surround to Protect Against Possible Shock	Red	\$44.27
LM-ULP-LS-Y-S	Long Shackle with Plastic Surround to Protect Against Possible Shock	Yellow	\$44.27
LM-DEPL	Non-Conductive De-Electric Long Shackle	Red	\$52.32
LM-PL	Electrical Plug Lock, up to 3" Ø & 5.5" Long, 1.25" Cable	Yellow	\$53.67



VYNCOSAFETYKIT



MCBLOCKOUTPACK



VLOLSY & VLOSSR
Actual product may differ from those pictured



VLOSSRA
Actual product may differ from those pictured



LM-DEPL
Actual product may differ from those pictured



LM-PL

LOCKOUT ACCESSORIES

Order Code	Description	Price excl. GST
LM-H-25	Insulated Lockout Hasp, 25mm Jaw	\$27.75
LM-H-38	Insulated Lockout Hasp, 38mm Jaw	\$30.70
LM-DH-6	Non-Conductive De-Electric Heavy Duty Nylon Lockout Hasp, 80mm Jaw	\$26.80
LM-MCL1	Circuit Breaker Lockout MCB Single (Yellow)	\$23.51
LM-MCBFL	Circuit Breaker Lockout MCB or Fuse, Pack of 5 Assorted	\$80.54
LM-UCBL	Circuit Breaker Lockout Universal Circuit Breaker, Pack of 4	\$73.82
LM-ST-1	"Isolate Switch" Lockout Tag	\$3.36
LM-ST-2	"Do Not Operate Electrician Working" Lockout Tag	\$3.36
LM-ST-3	"Do Not Start" Lockout Tag	\$3.36
LM-ST-4	"Out of Service" Lockout Tag	\$3.36



LM-H-25



LM-DH-6



LM-MCL1



LM-MCBFL



LM-UCBL



LM-ST-4

Actual product may differ from those pictured

CIRCUIT PROTECTION



GEOS LANDSCAPE BOXES

Our recently introduced landscape enclosures provide design flexibility for installation in exposed outside areas.

Built using glass-fibre reinforced polycarbonate, these electrical landscape enclosures offer strong weather protection, concealment, and durability to ensure the reliability of outdoor electrical installations. All too while blending seamlessly with their surroundings.

NEW

Key Features:

- Industrial quality IK09, IP66
- Transparent door
- Twist lock with 3mm double-bit insert



Polycarbonate Enclosures & Accessories	144
Polyester Enclosures & Accessories	148
Polyester Cabinets, Kits, & Accessories	151
Stainless Steel Cabinets	160
Outdoor Enclosure Accessories	162
Aluminium Cabinets	163
Polystyrene Enclosures & Accessories	164
HIBOX Enclosures & Accessories	167
Junction Boxes	172
Conduit Elbows & Bends	173

TG POLYCARBONATE ENCLOSURES



Order Code	Enclosure Reference	Dimensions (H x W x D)	Price excl. GST
20040301	TG PC 88-6-0	84 x 82 x 55mm	\$39.66
20090301	TG PC 88-9-0	84 x 82 x 85mm	\$43.94
20040401	TG PC 1208-6-0	122 x 82 x 55mm	\$43.12
20090401	TG PC 1208-9-0	122 x 82 x 85mm	\$49.98
20040501	TG PC 1212-6-0	124 x 122 x 55mm	\$49.98
20090501	TG PC 1212-9-0	124 x 122 x 85mm	\$56.09
20040601	TG PC 1608-6-0	162 x 82 x 55mm	\$52.12
20090601	TG PC 1608-9-0	162 x 82 x 85mm	\$59.23
20040701	TG PC 1612-9-0	162 x 122 x 90mm	\$71.38
20040801	TG PC 2012-8-0	202 x 122 x 75mm	\$75.79
20090801	TG PC 2012-9-0	202 x 122 x 90mm	\$84.79
20040901	TG PC 2015-9-0	202 x 152 x 90mm	\$80.51
20041201	TG PC 2016-9-0	252 x 162 x 90mm	\$95.05
20091201	TG PC 2516-12-0	252 x 162 x 120mm	\$118.09
20041301	TG PC 3023-9-0	302 x 232 x 90mm	\$155.61
20091301	TG PC 3023-11-0	302 x 232 x 110mm	\$180.98

Material
Polycarbonate

ENCLOSURES

FEATURES

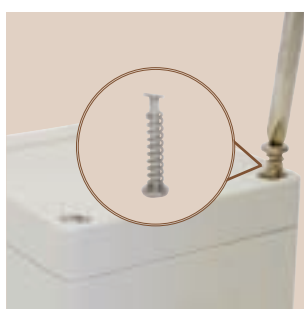

Easy cover removal with quarter turn screw ejection



Integrated cover retainer

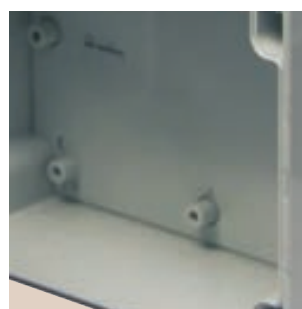

Moulded standoffs for installing a mounting plate or DIN rail



High gloss appearance with integrated cover recessed for labelling

TG PLASTIC MOUNTING PLATES

Order Code	To Suit	Dimensions (H x W)	Price excl. GST
18600301	TG PC 88	73 x 73mm	\$9.13
18600401	TG PC 1208	91 x 73mm	\$9.32
18600501	TG PC 1212	113 x 93mm	\$12.21
18600601	TG PC 1608	131 x 73mm	\$11.90
18600701	TG PC 1612	131 x 113mm	\$13.09
18600801	TG PC 2012	171 x 113mm	\$16.18
18600901	TG PC 2015	171 x 143mm	\$18.00
18601201	TG PC 2516	220 x 153mm	\$24.11
18601301	TG PC 3023	270 x 220mm	\$34.12

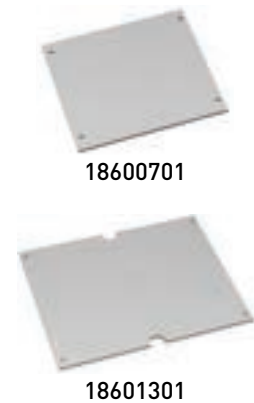

TG POLYCARBONATE ENCLOSURE ACCESSORIES



Order Code	Description	Quantity	Price excl. GST
18200801	Stainless Cover Screws 28mm	Set=8	\$31.60
18200901	Stainless Cover Screws 43mm	Set=10	\$42.18
18200201	External Brackets	Set=4	\$11.90



ENCLOSURES

GEOS LANDSCAPE BOXES



IP66 IK09 Halogen Free Outdoor Suitable Industry Quality

IEC 61439-7 RAL7035 Light Grey UV Resistant 



Order Code	Enclosure Reference	Dimensions (H x W x D)	Price excl. GST	Material
71175401	GEOS-S 5040-22-to	500 x 400 x 226mm	\$772.94	Polycarbonate
71174301	GEOS-S 4030-22-to	400 x 300 x 226mm	\$612.22	
71144301	GEOS-S 4030-18-to	400 x 300 x 180mm	\$550.03	

FEATURES



Designed for use in extreme industrial unprotected areas

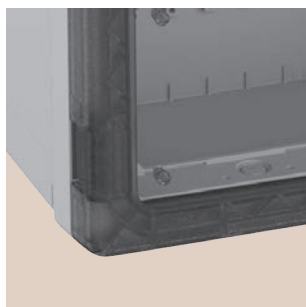

Box and frame: glass-fibre reinforced polycarbonate

ABOX-I JUNCTION BOXES

IP65

Outdoor Suitable

RAL7035 Light Grey

5 Pole Screw Terminals



Order Code	Description	Dimensions (H x W x D)	Screw Terminal Size	Price excl. GST	Material
49040201	ABOX-I 025 - 2.5	80 x 80 x 52mm	2.5mm ²	\$32.89	ASA-PC
49040401	ABOX-I 04 - 4.0	93 x 93 x 55mm	4mm ²	\$43.93	
49040601	ABOX-I 06 - 6.0	110 x 110 x 67mm	6mm ²	\$60.74	

FEATURES



Designed for use in extreme industrial unprotected areas



Mounted, removable terminal block



Stainless steel screws

ENCLOSURES

APO ENCLOSURES

IP67	IK10	Halogen Free	Outdoor Suitable	
IEC 60439-1 60529 62008	RAL7035 Light Grey	UV Resistant	Self Extinguishing	



Order Code	Enclosure Reference	Dimensions (H x W x D)	Price excl. GST
856048	AP01 BOX	185 x 150 x 130mm	\$220.93
856049	AP031 BOX	300 x 185 x 175mm	\$363.94
856050	AP041 BOX	300 x 300 x 175mm	\$346.07
856051	AP071 BOX	370 x 300 x 175mm	\$410.22
856052	AP051 BOX	485 x 300 x 175mm	\$484.77
856055	AP011 BOX	600 x 370 x 175mm	\$732.98

Material
Polyester (GFRP)

APO ENCLOSURE - TRANSPARENT COVER

IP66	IK10	Halogen Free	Outdoor Suitable	
IEC 60439-1 60529 62008	RAL7035 Light Grey	UV Resistant	Self Extinguishing	



Order Code	Enclosure Reference	Dimensions (H x W x D)	Price excl. GST
856057	AP01 T/C BOX	185 x 150 x 130mm	\$362.12
856058	AP031 T/C BOX	300 x 185 x 175mm	\$408.55
856060	AP071 T/C BOX	370 x 300 x 175mm	\$471.90
856061	AP051 T/C BOX	485 x 300 x 210mm	\$580.75
856064	AP011 T/C BOX	600 x 370 x 210mm	\$983.48

Material
Polycarbonate Cover + Polyester (GFRP) Body

ENCLOSURES

APO ENCLOSURE MOUNTING PLATES

Order Code	To Suit	Dimensions (H x W x D)	Price excl. GST
851190	AP01	140 x 110 x 4mm	\$27.06
851187	AP031	260 x 145 x 4mm	\$35.00
851278	AP041	260 x 260 x 4mm	\$45.62
851181	AP071	330 x 260 x 4mm	\$49.24
852091	AP051	450 x 260 x 4mm	\$63.18
851289	AP011	550 x 319 x 4mm	\$107.81



851181

APO ENCLOSURE DEPTH EXTENSION FRAME

Order Code	To Suit	Dimensions (H x W x D)	Price excl. GST
856041	AP031 DEF	300 x 185 x 35mm	\$157.18
856042	AP041 DEF	300 x 300 x 35mm	\$174.91



856042

Note: No depth extension frame for AP051. Using a depth extension frame reduces IP rating to IP55.

APO ENCLOSURE ACCESSORIES

Order Code	Description	Quantity	Price excl. GST
856109	Type A Hinge (Use with APO Enclosure)	Set=2	\$49.01
856112	Type D Hinge (Use with APO Enclosure with Transparent Cover)	Set=2	\$42.11
833677	Vent Grid IP44	Set=2	\$40.93
852025	Mounting Bracket Stainless	Set=4	\$100.32
851255E	Cover Fixing Screws	Each	\$3.12
851026	Threaded Insert M4	Each	\$7.56



856109



856112













833677



852025

ARIA CABINETS - WITH PERTINAX MOUNTING PLATE

 IK10	 IEC 60439-1 60529 62008	 Halogen Free	 Outdoor Suitable	
 IP66	 RAL7035 Light Grey	 UV Resistant	 Self Extinguishing	



Order Code	Enclosure Reference	Dimensions (H x W x D)	Price excl. GST
ARIA32GT	ARIA 32	315 x 215 x 170mm	\$471.95
ARIA43GT	ARIA 43	415 x 315 x 170mm	\$533.59
ARIA54GT	ARIA 54	515 x 415 x 230mm	\$860.44
ARIA64GT	ARIA 64	615 x 415 x 230mm	\$937.17
ARIA75GT	ARIA 75	735 x 535 x 270mm	\$1327.49
ARIA86GT	ARIA 86	835 x 635 x 300mm	\$1656.31
ARIA108GT	ARIA 108	1035 x 835 x 300mm	\$2903.07

Material
Polyester (GFRP)

Cabinets supplied with 3mm double bit lock.

ENCLOSURES

FEATURES



Poured in rubber gasket



Double skinned wall



3 point locking system on larger enclosures

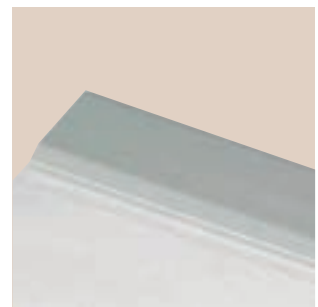

Comes with rain hood

ARIA CABINETS

IP66	IK10	Halogen Free	Outdoor Suitable	
IEC 60439-1 60529 62008	RAL7035 Light Grey	UV Resistant	Self Extinguishing	



Order Code	Enclosure Reference	Dimensions (H x W x D)	Price excl. GST
831025	ARIA 32C	315 x 215 x 170mm	\$513.11
831035	ARIA 43C	415 x 315 x 170mm	617.06
831052	ARIA 54C	515 x 415 x 230mm	\$996.61
831065	ARIA 64C	615 x 415 x 230mm	\$1008.28
831081	ARIA 75C	735 x 535 x 270mm	\$1392.19
831098	ARIA 86C	835 x 635 x 300mm	\$1703.00
831112	ARIA 108C	1035 x 835 x 300mm	\$3005.58

Material
Polyester (GFRP)

Cabinets supplied with 3mm double bit lock / Mounting Plate sold separately.

ARIA CABINETS WITH GLAZED DOOR

IP66	IK07	Halogen Free	Outdoor Suitable	
IEC 60439-1 60529 62008	RAL7035 Light Grey	UV Resistant	Self Extinguishing	

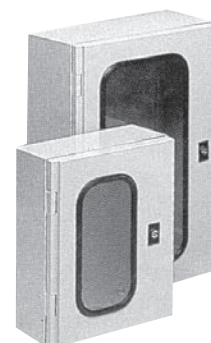

Order Code	Enclosure Reference	Dimensions (H x W x D)	Price excl. GST
831128	ARIA 43GD	415 x 315 x 170mm	\$1164.29
831129	ARIA 54GD	515 x 415 x 230mm	\$1617.67
831130	ARIA 64GD	615 x 415 x 230mm	\$1554.51
831131	ARIA 75GD	735 x 535 x 270mm	\$2109.57
831132	ARIA 86GD	835 x 635 x 300mm	\$2894.21
831133	ARIA 108GD	1035 x 835 x 300mm	\$4565.38

Material
Polyester (GFRP)

Glazing with 6mm polycarbonate panel.

ARIA CABINET DIN MOUNT FRAMES KITS

Order Code	Reference	Description	Price excl. GST
831030	ARIA 32DMF	2 Rows/ 12 Modules	\$154.50
831041	ARIA 43DMF	2 Rows/ 24 Modules	\$168.29
831057	ARIA 54DMF	3 Rows/ 54 Modules	\$208.56
831086	ARIA 75DMF	4 Rows/ 88 Modules	\$291.13
831103	ARIA 86DMF	4 Rows/ 112 Modules	\$306.13
831117	ARIA 108DMF	5 Rows/ 200 Modules	\$465.57



831057

ARIA CABINET DIN COVER PLATE KITS

Order Code	Reference	Dimensions (H x W)	Price excl. GST
831040	ARIA 43DCP	400 x 300mm	\$265.37
831056	ARIA 54DCP	500 x 400mm	\$306.47
831085	ARIA 75DCP	700 x 500mm	\$353.71



831056

ARIA CABINET PLAIN COVER PLATE KITS

Order Code	Reference	Dimensions (H x W)	Price excl. GST
831039	ARIA 43PCP	400 x 300mm	\$183.08
831055	ARIA 54PCP	500 x 400mm	\$195.72
831084	ARIA 75PCP	700 x 500mm	\$270.32



831084

ARIA CABINET PERTINAX MOUNTING PLATES

Order Code	Reference	Dimensions (H x W x D)	Price excl. GST
831027	ARIA 32PP	250 x 140 x 4mm	\$37.57
831038	ARIA 43PP	350 x 250 x 4mm	\$60.25
831054	ARIA 54PP	450 x 350 x 4mm	\$86.12
831067	ARIA 64PP	550 x 350 x 4mm	\$102.19
831083	ARIA 75PP	650 x 450 x 4mm	\$187.00
831100	ARIA 86PP	750 x 550 x 4mm	\$258.13
831114	ARIA 108PP	950 x 750 x 4mm	\$435.19



831054

ARIA CABINET SPARE DOORS

Order Code	Enclosure Reference	Price excl. GST
831024	ARIA 32	\$394.66
831033	ARIA 43	\$424.13
831050	ARIA 54	\$450.36
831063	ARIA 64	\$541.84
831079	ARIA 75	\$563.93
831096	ARIA 86	\$810.05
831110	ARIA 108	\$1630.48



831024

ENCLOSURES

ARIA CABINET ACCESSORIES

Order Code	Description	Quantity	Price excl. GST
831000	Stainless Wall Mounting Bracket	Set=4	\$113.19
831001	Polyamide Wall Mounting Bracket	Set=4	\$66.24
831009	Vent Grids (IP44)	Set=2	\$22.13
831344	Depth Extension Brackets	Set=4	\$133.61

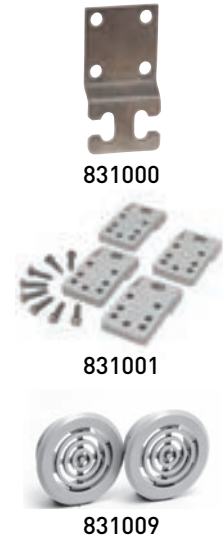

ARIA CABINET HANDLES & LOCKS

Order Code	Description	Price excl. GST
831003	Neutral Handle	\$82.60
831004	Handle with Lock & 2 Keys V2432E	\$178.28
831005	Lock Insert & Key Square 8mm	\$30.58
831006	Lock Insert & Key Triangular 8mm	\$34.35
831007	Lock Insert & Key Triangular 11mm	\$30.72
831008	Lock & Key Double Bit 3mm	\$32.53
831821	Swing Handle for Profile Half Cylinder Lockable	\$231.54
832026	Square Key Only 8mm	\$22.86
832027	Triangular Key Only 8mm	\$25.77
832028	Double Bit Key Only 3mm	\$21.16



ENCLOSURES

POLYSAFE CABINETS WITH SINGLE DOORS

IP65	IK10	Halogen Free	Outdoor Suitable	
IEC 60529 62208 62262	RAL7035 Light Grey	UV Resistant	Self Extinguishing	



Order Code	Reference	Dimensions (H x W x D)	Price excl. GST
833000	PS 220	500 x 500 x 320mm	\$2258.09
833024	PS 420	1000 x 500 x 320mm	\$3122.25
833028	PS 430	1000 x 750 x 320mm	\$4023.73

Material
Polyester (GFRP)

All Polysafe cabinets are complete with handle and wall mounting brackets (AISI 304 stainless steel)
Locks (profile half cylinder type) to be ordered separately. Cabinet with depth extension kit available on request.

ENCLOSURES

EH1 PEDESTAL

IP23 for Top	RAL7036 for Top	IK10	Outdoor Suitable	Halogen Free
IP43 for Base	RAL9005 for Base	UV Resistant	Self Extinguishing	



Order Code	Description	Dimensions (H x W x D)	Price excl. GST
841037	EH1N Pedestal Ventilated	752 x 385 x 270mm	\$517.22

Material
Polyester (GFRP) Body + Polyethylene Base

POLYSAFE CABINET MOUNTING PLATES

Order Code	Reference	Dimensions (H x W)	Price excl. GST
833508	PS 220 (Pertinax 5mm)	390 x 390mm	\$198.14
833511	PS 420 (Pertinax 5mm)	890 x 390mm	\$371.50
833512	PS 430 (Pertinax 5mm)	640 x 890mm	\$470.57



8335

POLYSAFE CABINET LOCKS AND KEYS

Order Code	Reference	Price excl. GST
832030	Lock & 2 Keys E2432 (Previous unit V2432-E)	\$237.82
832033	Lock & Key Triangular 8mm	\$216.71
832034	Lock & Key Triangular 11mm	\$238.46



832030

POLYSAFE CABINET ACCESSORIES

Order Code	Description	Dimensions (H x W x D)	Price excl. GST
833653	Corner Profile	Length=308mm	\$70.11
833677	Air Vents (IP44) Set=2	-	\$40.93



833653

ENCLOSURES

HINGED WINDOWS - OUTDOOR SUITABLE

Order Code	Description	Dimensions (H x W)	Price excl. GST
40444	2 Way (IP67)	77 x 50mm	\$58.08
40986	6 Way (IP67)	77 x 130mm	\$82.84
40979	8 Way (IP67)	77 x 163mm	\$100.59
40981	12 Way (IP67)	77 x 240mm	\$110.97



40979

DIN RAIL MOUNTING KITS FOR HINGED WINDOWS

Order Code	Installation Kit Description	Price excl. GST
41431	6 Way, for use with 40986	\$97.35
41432	8 Way, for use with 40979	\$101.30
41433	12 Way, for use with 40981	\$110.50



41431

SURFACE WINDOWS

Order Code	Description	Dimensions (H x W)	Price excl. GST
866001	IP67	211 x 262mm	\$180.37
866003	IP67	217 x 139mm	\$170.47



866001

VENTING ACCESSORIES

Order Code	Description	Quantity	Price excl. GST
818223	Pressure Compensation Plugs (IP66) Polyamide 6, RAL7035 1200 l/h at >70 mbar, Cut-out Ø 40mm	Set=2	\$147.57
831009	Vent Grids (IP44)	Set=2	\$22.13
833677	Air Vents (IP44)	Set=2	\$40.93
DSVH-40	Ventilator, Straight	Each	\$13.54



831009



833677

Suits ARIA, APO, Polysafe enclosures.

VSTX STAINLESS STEEL CABINETS

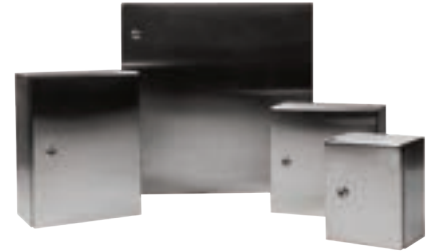

Order Code	Dimensions (H x W x D)	Price excl. GST	Material
VSTX2215	250 x 200 x 150mm	\$373.36	304 Stainless Steel
VSTX3315	300 x 300 x 150mm	\$478.02	
VSTX4320	400 x 300 x 200mm	\$654.51	
VSTX5420	500 x 400 x 200mm	\$889.68	
VSTX6420	600 x 400 x 200mm	\$1023.11	
VSTX6625	600 x 600 x 250mm	\$1411.93	
VSTX8630	800 x 600 x 300mm	\$1924.83	
VSTX10830	1000 x 800 x 300mm	\$3021.61	

*Excludes VSTX10830 (IP55)
304 Stainless cabinets supplied with steel mounting plate and 3mm stainless steel bit lock.

VST POWDERCOATED STEEL CABINETS



Order Code	Dimensions (H x W x D)	Price excl. GST	Material
VST2215	250 x 200 x 150mm	\$137.89	Powdercoated Steel
VST3215	300 x 250 x 150mm	\$166.82	
VST3315	300 x 300 x 150mm	\$187.09	
VST4320	400 x 300 x 200mm	\$235.35	
VST4420	400 x 400 x 200mm	\$258.38	
VST5420	500 x 400 x 200mm	\$273.91	
VST5430	500 x 400 x 300mm	\$495.56	
VST5525	500 x 500 x 250mm	\$376.21	
VST6425	600 x 400 x 250mm	\$311.10	
VST6620	600 x 600 x 200mm	\$436.75	
VST6630	600 x 600 x 300mm	\$628.59	
VST7525	700 x 500 x 250mm	\$545.94	
VST8630	800 x 600 x 300mm	\$865.98	
VST10830	1000 x 800 x 300mm	\$1485.82	

ENCLOSURES

POLE MOUNT KITS - STAINLESS STEEL

Order Code	Suitable for these VYNCO Enclosures	Width	Price excl. GST
PMK1	APO31, CSP22E, CSP42E, VSTX2215	250mm	\$91.87
PMK1A	APO41, APO71, APO51, VSTX3315, VSTX4320,	300mm	\$125.00
PMK2	APO11, ARIA 43, ARIA 54, ARIA 64, VSTX5420, VSTX6420	400mm	\$145.25
PMK3	VSTX6625, VSTX8630, ARIA75	600mm	\$225.17



PMK1



PMK2

Kits include 2 x stainless steel brackets, nuts and bolts. Strapping not included.

KIOSKS - BASE-SETS

- IP44
- Padlockable Handle
- Custom Powdercoat Available
- Custom Sizes on Request



Order Code	Overall Size (H x W x D)	Price excl. GST	Material
KS121246	1250 x 1200 x 460mm	\$6124.26	Marine Grade Aluminium
KS121546	1250 x 1500 x 460mm	\$6547.98	
KS151546	1500 x 1500 x 460mm	\$9783.04	
KS151746	1500 x 1700 x 460mm	\$8031.38	
KS171546	1700 x 1500 x 460mm	\$8049.65	
KS171746	1700 x 1700 x 460mm	\$8593.91	
KS172046	1700 x 2000 x 460mm	\$9783.04	
KS172246	1700 x 2200 x 460mm	\$10462.21	
KS201546	2000 x 1500 x 460mm	\$9127.69	
KS201746	2000 x 1700 x 460mm	\$9917.69	
KS202046	2000 x 2000 x 460mm	\$11110.93	
KS222246	2200 x 2200 x 460mm	\$11637.02	

ENCLOSURES

TK ENCLOSURES

IP66	IK07	Halogen Free	Indoor Suitable
IEC 60529 62208 62262	RAL7035 Light Grey	High Chemical Resistance	Self Extinguishing



OrderCode	Enclosure Reference	Dimensions (H x W x D)	Mounting Plate Reference	Price excl. GST
11040101	TK 01-6	65 x 65 x 57mm	MB 11	\$21.97
11090101	TK 01-8	65 x 65 x 81mm	MB 11	\$28.20
11040201	TK 02-6	94 x 65 x 57mm	MB 21	\$26.44
11090201	TK 02-8	94 x 65 x 81mm	MB 21	\$31.73
11040301	TK 03-6	94 x 94 x 57mm	MB 22	\$28.83
11090301	TK 03-8	94 x 94 x 81mm	MB 22	\$33.61
11040901	TK 04-6	130 x 94 x 57mm	MB 42	\$38.21
11090901	TK 04-8	130 x 94 x 81mm	MB 42	\$44.57
11040401	TK 05-7	110 x 110 x 66mm	MB 33	\$40.35
11090401	TK 05-9	110 x 110 x 90mm	MB 33	\$48.16
11040501	TK 06-7	130 x 130 x 75mm	MB 44	\$49.35
11090501	TK 06-10	130 x 130 x 99mm	MB 44	\$53.44
11041001	TK 07-6	180 x 94 x 57mm	MB 52	\$48.16
11091001	TK 07-8	180 x 94 x 81mm	MB 52	\$49.85
11040601	TK 08-9	180 x 110 x 90mm	MB 53	\$62.82
11090601	TK 08-11	180 x 110 x 111mm	MB 53	\$67.04
10940601	TK 08-16	180 x 110 x 165mm	MB 53	\$99.46
11040701	TK 09-9	182 x 180 x 90mm	MB 65	\$74.47
11090701	TK 09-11	182 x 180 x 111mm	MB 65	\$79.06
10940701	TK 09-16	182 x 180 x 165mm	MB 65	\$129.30
11040801	TK 10-9	254 x 180 x 90mm	MB 75	\$102.48
11090801	TK 10-11	254 x 180 x 111mm	MB 75	\$125.58
10940801	TK 10-16	254 x 180 x 165mm	MB 75	\$191.17
11041201	TK 11-11	361 x 254 x 111mm	MB 87	\$211.82
11091201	TK 11-16	361 x 254 x 165mm	MB 87	\$255.44

Material
Polystyrene

ENCLOSURES

TK ENCLOSURES - TRANSPARENT COVER

IP66	IK07	Halogen Free	Indoor Suitable
IEC 60529 62208 62262	RAL7035 Light Grey	Self Extinguishing	



Order Code	Enclosure Reference	Dimensions (H x W x D)	Mounting Plate Reference	Price excl. GST
11151001	TK 07-8t	180 x 94 x 81mm	MB52	\$55.52
11100601	TK 08-9t	180 x 110 x 90mm	MB 53	\$66.41
11150601	TK 08-11t	180 x 110m x 111mm	MB 53	\$70.25
11100701	TK 09-9t	182 x 180 x 90mm	MB 65	\$105.38
11150701	TK 09-11t	182 x 180 x 111mm	MB 65	\$149.00
11200701	TK 09-16t	182 x 180 x 165mm	MB 65	\$202.00
11100801	TK 10-9t	254 x 180 x 90mm	MB 75	\$140.05
11150801	TK 10-11t	254 x 180 x 111mm	MB 75	\$180.35
11200801	TK 10-16t	254 x 180 x 165mm	MB 75	\$255.95
11151201	TK 11-16t	361 x 254 x 165mm	MB 87	\$389.07

Material
Polycarbonate Cover + Polystyrene Body

Note: Extra depth added by lid, base dimensions remain the same as opaque version.

ENCLOSURES

TK ENCLOSURE MOUNTING PLATES

Order Code	Enclosure Reference	Dimensions (H x W)	Mounting Plate Reference	Price excl. GST
861730	TK 01	45 x 45mm	MB 11	\$12.61
861731	TK 02	74 x 45mm	MB 21	\$12.61
861732	TK 03	74 x 74mm	MB 22	\$13.10
861733	TK 04	110 x 74mm	MB 42	\$15.95
861734	TK 05	90 x 90mm	MB 33	\$15.95
861735	TK 06	110 x 110mm	MB 44	\$17.82
861736	TK 07	160 x 74mm	MB 52	\$19.39
861737	TK 08	160 x 90mm	MB 53	\$20.15
861738	TK 09	150 x 150mm	MB 65	\$26.29
861739	TK 10	220 x 150mm	MB 75	\$31.31
861740	TK 11	335 x 220mm	MB 87	\$64.08



861739

Plastic, 2.5mm thick including self-tapping fastening screws.

TK ENCLOSURE HINGE SETS

Order Code	Enclosure Reference	Description	Quantity	Price excl. GST
19000501	TK08 to TK11	Hinge Set (IP54)	Set=2	\$28.45



19000501

POLYSTYRENE ENCLOSURE ACCESSORIES

Order Code	Description	Quantity	Price excl. GST
19400101	Wall Mounting Brackets	Set=4	\$17.18
26240301	Air Vent (IPX4)	Each	\$6.68
19001001	Cover Screw 35mm	Each	\$6.61
19001101	Cover Screw 58mm	Each	\$9.25



26240301

HIBOX DSAG ENCLOSURES - FIXED COVER

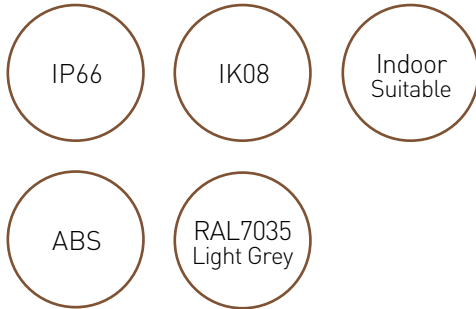

Order Code	Dimensions (H x W x D)	Range	Price excl. GST	Material
DSAG0811-S	80 x 110 x 45mm	HIBOX1	\$30.29	ABS
DSAG0811	80 x 110 x 70mm	HIBOX1	\$39.44	
DSAG0811-1	80 x 110 x 85mm	HIBOX1	\$44.44	
DSAG0813	80 x 130 x 70mm	HIBOX1	\$43.44	
DSAG0813-1	80 x 130 x 85mm	HIBOX1	\$49.78	
DSAG0818	80 x 180 x 70mm	HIBOX1	\$47.10	
DSAG0818-1	80 x 180 x 85mm	HIBOX1	\$55.65	
DSAG0825	80 x 250 x 70mm	HIBOX1	\$55.25	
DSAG0825-1	80 x 250 x 85mm	HIBOX1	\$61.86	
DSAG1212-S	125 x 125 x 75mm	HIBOX1	\$58.05	
DSAG1212	125 x 125 x 100mm	HIBOX1	\$62.65	
DSAG1217	125 x 175 x 75mm	HIBOX1	\$70.06	
DSAG1217-1	125 x 175 x 100mm	HIBOX1	\$74.60	
DSAG1417	140 x 170 x 95mm	HIBOX1	\$70.39	
DSAG1520	150 x 200 x 100mm	HIBOX1	\$76.14	
DSAG1520-1	150 x 200 x 130mm	HIBOX1	\$78.80	
DSAG1525	150 x 250 x 100mm	HIBOX1	\$84.54	
DSAG1525-1	150 x 250 x 130mm	HIBOX1	\$87.74	
DSAG2020-S	200 x 200 x 95mm	HIBOX1	\$91.68	
DSAG2020	200 x 200 x 130mm	HIBOX1	\$93.74	
DSAG1919	190 x 190 x 130mm	HIBOX2	\$156.96	
DSAG2819	190 x 280 x 130mm	HIBOX2	\$197.57	
DSAG2819-1	280 x 190 x 130mm	HIBOX2	\$225.19	
DSAG3819	380 x 190 x 130mm	HIBOX2	\$236.27	
DSAG3819-1	380 x 190 x 180mm	HIBOX2	\$270.76	
DSAG2828	280 x 280 x 130mm	HIBOX2	\$245.68	
DSAG2834	280 x 340 x 130mm	HIBOX2	\$253.95	
DSAG2838	280 x 380 x 130mm	HIBOX2	\$296.39	
DSAG2838-1	280 x 380 x 180mm	HIBOX2	\$340.23	
DSAG5628	560 x 280 x 130mm	HIBOX2	\$437.38	
DSAG5638	560 x 360 x 180mm	HIBOX2	\$556.48	

HIBOX3 NEAG ENCLOSURES - HINGED COVER

IP66	IK08	Indoor Suitable
ABS	RAL7035 Light Grey	Hinged & Clipped Lid



HIBOX3

Order Code	Dimensions (H x W x D)	Range	Price excl. GST
ENAG1515	150 x 150 x 90mm	HIBOX3	\$82.40
NEAG1722	170 x 220 x 110mm	HIBOX3	\$132.85
NEAG1727	170 x 270 x 110mm	HIBOX3	\$145.59
NEAG1929-S	190 x 290 x 100mm	HIBOX3	\$200.37
NEAG1929	190 x 290 x 140mm	HIBOX3	\$232.81
NEAG3030-S	300 x 300 x 130mm	HIBOX3	\$257.29
NEAG3030	300 x 300 x 180mm	HIBOX3	\$284.64
NEAG2939-S	290 x 390 x 100mm	HIBOX3	\$242.61
NEAG2939	290 x 390 x 160mm	HIBOX3	\$274.10
NEAG3546-S	350 x 465 x 160mm	HIBOX3	\$453.19
NEAG3546	350 x 465 x 200mm	HIBOX3	\$474.47
ENAG4353-S *	430 x 530 x 160mm	HIBOX3	\$558.55
ENAG4353 *	430 x 530 x 200mm	HIBOX3	\$590.11
ENAG5060 *	500 x 600 x 250mm	HIBOX3	\$821.98
ENAG5070 *	500 x 700 x 250mm	HIBOX3	\$1064.39

Material
ABS

HIBOX3 enclosures are supplied with stainless wall brackets.

*Supplied with depth extension frame.

HIBOX ENCLOSURES - TRANSPARENT COVER

IP66	IK08	Indoor Suitable
Clear & Fixed Lid	ABS	RAL7035 Light Grey



Order Code	Dimensions (H x W x D)	Range	Price excl. GST	Material
DSAT0811-1	80 x 110 x 85mm	HIBOX1	\$56.53	Polycarbonate Cover + ABS Body
DSAT1212-S	125 x 125 x 75mm	HIBOX1	\$62.12	
DSAT1217	125 x 175 x 75mm	HIBOX1	\$73.99	
DSAT1217-1	125 x 175 x 100mm	HIBOX1	\$78.20	
DSAT1417	140 x 170 x 95mm	HIBOX1	\$82.28	
DSAT1520	150 x 200 x 100mm	HIBOX1	\$83.67	
DSAT1520-1	150 x 200 x 130mm	HIBOX1	\$92.39	
DSAT1525	150 x 250 x 100mm	HIBOX1	\$94.48	
DSAT1525-1	150 x 250 x 130mm	HIBOX1	\$102.75	
DSAT2020	200 x 200 x 130mm	HIBOX1	\$102.02	
DSAT1919	190 x 190 x 130mm	HIBOX2	\$175.49	
DSAT2819	280 x 190 x 130mm	HIBOX2	\$217.92	
DSAT3819	380 x 190 x 130mm	HIBOX2	\$248.48	
DSAT3819-1	380 x 190 x 180mm	HIBOX2	\$297.06	
DSAT2828	280 x 280 x 130mm	HIBOX2	\$282.38	
DSAT2838	280 x 380 x 130mm	HIBOX2	\$327.35	
DSAT2838-1	280 x 380 x 180mm	HIBOX2	\$380.06	
DSAT5628	560 x 280 x 130mm	HIBOX2	\$438.91	
DSAT5638	560 x 280 x 180mm	HIBOX2	\$600.99	
NEAT1515	150 x 150 x 90mm	HIBOX3	\$92.18	
NEAT1929-S	190 x 290 x 100mm	HIBOX3	\$208.65	
NEAT1929	190 x 290 x 140mm	HIBOX3	\$240.35	
NEAT3030-S	300 x 300 x 130mm	HIBOX3	\$265.57	
NEAT3030	300 x 300 x 180mm	HIBOX3	\$293.06	
NEAT2939-S	290 x 390 x 100mm	HIBOX3	\$250.81	
NEAT2939	290 x 390 x 160mm	HIBOX3	\$282.65	
NEAT3546-S	350 x 465 x 160mm	HIBOX3	\$461.60	
NEAT3546	350 x 465 x 200mm	HIBOX3	\$482.75	
ENAT5070-S *	500 x 700 x 180mm	HIBOX3	\$977.91	
ENAT5070 *	500 x 700 x 250mm	HIBOX3	\$1072.80	

HIBOX3 Enclosures are supplied with stainless wall mounting brackets.
*Supplied with plastic internal frame.

ENCLOSURES

HIBOX1 PLASTIC MOUNTING PLATES

Order Code	Dimensions (H x W)	Price excl. GST
DS0811PP	65 x 95mm	\$8.59
DS0813PP	65 x 115mm	\$9.87
DS0818PP	65 x 165mm	\$10.49
DS0825PP	65 x 235mm	\$14.90
DS1212PP	110 x 110mm	\$17.05
DS1217PP	110 x 155mm	\$17.05
DS1417PP	125 x 155mm	\$17.05
DS1520PP	135 x 185mm	\$20.49
DS1525PP	135 x 235mm	\$22.94
DS2020PP	185 x 185mm	\$40.48

Material

4mm PVC



DS0818PP

HIBOX2 PLASTIC MOUNTING PLATES

Order Code	Dimensions (H x W)	Price excl. GST
DS1919PP	135 x 135mm	\$27.48
DS2819PP	135 x 230mm	\$33.00
DS3819PP	135 x 325mm	\$40.48
DS2828PP	230 x 230mm	\$39.68
DS2834PP	220 x 280mm	\$52.13
DS2838PP	225 x 325mm	\$52.13
DS5628PP	235 x 505mm	\$88.32
DS5638PP	320 x 510mm	\$96.35

Material

4mm PVC



DS2819PP

HIBOX3 PLASTIC MOUNTING PLATES

Order Code	Dimensions (H x W)	Price excl. GST
NE1515PP	120 x 125mm	\$21.46
NE1722PP	140 x 190mm	\$34.17
NE1727PP	140 x 240mm	\$33.37
NE1929PP	160 x 240mm	\$34.95
NE3030PP	280 x 280mm	\$46.91
NE2939PP	250 x 350mm	\$53.73
NE3546PP	325 x 455mm	\$97.03
NE4353PP	370 x 465mm	\$158.85
NE5060PP	470 x 570mm	\$166.03
NE5070PP	470 x 670mm	\$181.36

Material

4mm PVC



NE2939PP

HIBOX ACCESSORIES

Order Code	Description	Quantity	HIBOX1	HIBOX2	HIBOX3	Price excl. GST
DSVH-40	Ventilator Straight	Each	✓	✓	✓	\$14.22
DSK-20KIT	Enclosure Key Lock Kit	Each	✓	✓	✓	\$64.67
DSK-40KIT	Padlocking Bracket Kit	Each	✓	✓		\$46.14
DSH-35KIT	Hinges	Set=2	✓			\$27.94
DSH-50KIT	Hinges	Set=2		✓		\$28.12
DSM-65	Draw Latch Stainless Steel	Each		✓		\$46.47
DSB-40KIT	Stainless Steel Wall Mounting Brackets	Set=2	✓		✓	\$7.52
DSB-50KIT	Stainless Steel Wall Mounting Brackets	Set=2		✓	✓	\$8.17
DSIHP-1929	Internal Hinged Panel suit NEAG/T - 1929	Each			✓	\$292.08
DSIHP-2939	Internal Hinged Panel suit NEAG/T - 2939	Each			✓	\$357.49
DSIHP-3030	Internal Hinged Panel suit NEAG/T - 3030	Each			✓	\$341.10
DSB-25	Plastic Cover Screw 25mm	Each	✓			\$2.06
DSB-33	Plastic Cover Screw 33mm	Each	✓			\$2.06
DSB-49	Plastic Cover Screw 49mm	Each		✓		\$2.06
DSB-70	Plastic Cover Screw 70mm	Each	✓			\$2.06
DSB-110	Plastic Cover Screw 110mm	Each		✓		\$2.06



DSVH-40



DSH-35KIT



DSB-40KIT



DSM-65

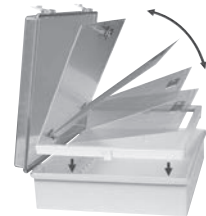

HIBOX Fitted with Internal Hinged Panel

HANDLE + LOCK OPTIONS

Order Code	Description	Price excl. GST
MB50604V	Standard Handle	\$49.51
MB50605V	Lock 2 Keys (144)	\$38.42



MB50604V

ABOX JUNCTION BOXES



Order Code	Enclosure Reference	Dimensions (H x W x D)	Screw Terminal Size	Price excl. GST	Material
80240701	ABOX 025 - 2.5	80 x 80 x 52mm	2.5mm ²	\$18.45	Polystyrene
80440701	ABOX 04 - 4.0	93 x 93 x 55mm	4mm ²	\$22.33	
80640701	ABOX 060 - 6.0	110 x 110 x 67mm	6mm ²	\$45.14	

SD7 JUNCTION BOXES



Order Code	Dimensions (H x W x D)	Screw Terminal Size	Price excl. GST	Material
33240701	75 x 75 x 37mm	c/w 5 Pole Screw Terminals 2.5mm ² Sd7	\$5.77	Polystyrene

DON BOX

- IP65
when used
with a suitable
silicone sealant
- Captive
Stainless
Steel Screws
Incl.
- 3 Bungs
Included
- UV
Stabilised



PATENT
APPLIES
VYNCO Industries

Order Code	Conduit Size	Price excl. GST	Material
DBX20	20mm	\$13.09	PVC
DBX25	25mm	\$14.08	

FEATURES

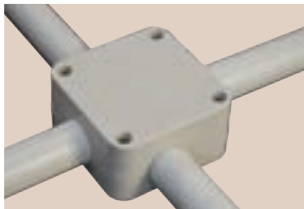

Replace all conduit junction boxes with the Don Box



Two part boxes, elbows, and bends allow for easy installation



Designed in New Zealand

Carton Qty

Box Qty: 10

DON ELBOW

- IP52
When used
with a suitable
silicone sealant
- Captive
Stainless
Steel Screws
Incl.
- UV
Stabilised
- Box Qty: 20



PATENT
APPLIES
VYNCO Industries

Order Code	Conduit Size	Price excl. GST	Material
DEL20	20mm	\$8.17	PVC
DEL25	25mm	\$8.51	

DON BEND

- IP52
when used
with a suitable
silicone sealant
- Captive
Stainless
Steel Screws
Incl.
- UV
Stabilised
- Box Qty: 20



PATENT
APPLIES
VYNCO Industries

Order Code	Conduit Size	Price excl. GST	Material
DBD20	20mm	\$7.51	PVC
DBD25	25mm	\$8.38	



DUO WALL MOUNTED RECEPTACLE

NEW

The widely used 16A and 32A wall-mounted receptacles with switched and interlocked features have been improved!

These receptacles are designed to provide enhanced safety, flexibility, and control for a wide range of electrical applications, from residential installations to industrial settings.



Designed for quick installation

Strong and lasting materials

Effective and simple operation

Isolators & Switches	176
Sockets	177
Switches	179
Plugs	180
Connectors	182
Enclosures	183
Industrial Plugs & Sockets	184
Plug & Socket Accessories	193
Container Products	194
NATO Plugs & Sockets	195
Caravan and Marine Sockets & Connectors	196
Caravan and Marine Leads & Plugs	198

ISOLATORS & SWITCHES

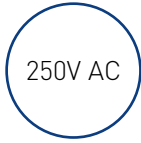

Order Code	Description	Dimensions	Poles	Current Rating	Price excl. GST	Carton Qty
WPS1	Isolator	85 x 85 x 83mm	1	20A	\$90.15	Box Qty: 1 Shipper Qty: 30 (except WPS120C & WPS1)
WPS120	Isolator	170 x 85 x 90mm	1	20A	\$99.78	
WPS120C	Isolator	85 x 85 x 83mm	2	20A	\$102.11	Box Qty: 1 Shipper Qty: 60 (for WPS120C & WPS1)
WPS135	Isolator	170 x 85 x 90mm	1	35A	\$107.17	
WPS320	Isolator	170 x 85 x 90mm	3	20A	\$107.50	
WPS335	Isolator	170 x 85 x 90mm	3	35A	\$123.99	

T-WREX COMBINATION SWITCHED SOCKETS



Order Code	Pins	Current Rating	Voltage	Price excl. GST
VCV310	3 Flat	10A	250V AC	\$172.20
VCV315	3 Flat	15A	250V AC	\$186.33
VC3/6C	3 Round (CEE)	16A	250V AC	\$227.80
VCV320	3 Round	20A	250V AC	\$230.02
VCV332	3 Round	32A	250V AC	\$285.28
VCV416	4 Round	16A	500V AC	\$258.29
VCV420	4 Round	20A	500V AC	\$295.56
VCV432	4 Round	32A	500V AC	\$321.26
VCV440	4 Round	40A	500V AC	\$424.07
VCV450	4 Round	50A	500V AC	\$462.62
VCV516	5 Round	16A	500V AC	\$289.14
VCV520	5 Round	20A	500V AC	\$323.83
VCV532	5 Round	32A	500V AC	\$424.07
VCV540	5 Round	40A	500V AC	\$507.59
VCV550	5 Round	50A	500V AC	\$591.12

Operating Temp (°C)
-20 to +50
Carton Qty
Box Qty: 1 Shipper Qty: 45

T-WREX SOCKET OUTLETS - 3 PIN

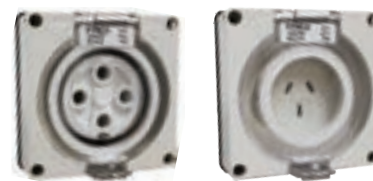

Order Code	Pins	Current Rating	Voltage	Price excl. GST	Operating Temp (°C)
VS0310	3 Flat	10A	250V AC	\$109.23	-20 to +50
VS0315	3 Flat	15A	250V AC	\$118.22	
VS3/6C	3 Round (CEE)	16A	250V AC	\$90.92	Carton Qty
VS0320	3 Round	20A	250V AC	\$119.51	
VS0332	3 Round	32A	250V AC	\$140.07	Box Qty: 1 Shipper Qty: 45 (except VS0310 & VS0315)
VS0416	4 Round	16A	500V AC	\$111.80	Box Qty: 1 Shipper Qty: 60 (for VS0310 & VS0315)
VS0420	4 Round	20A	500V AC	\$113.08	
VS0432	4 Round	32A	500V AC	\$143.93	
VS0440	4 Round	40A	500V AC	\$244.16	
VS0450	4 Round	50A	500V AC	\$276.29	
VS0516	5 Round	16A	500V AC	\$128.50	
VS0520	5 Round	20A	500V AC	\$170.91	
VS0532	5 Round	32A	500V AC	\$196.61	
VS0540	5 Round	40A	500V AC	\$276.29	
VS0550	5 Round	50A	500V AC	\$301.99	

INDUSTRIAL
PLUGS & SOCKETS

T-WREX SWITCHES



Order Code	Poles	Current Rating	Voltage	Price excl. GST
VSW110	1	10A	250V AC	\$78.39
VSW116	1	16A	250V AC	\$80.67
VSW120	1	20A	250V AC	\$92.52
VSW132	1	32A	250V AC	\$91.24
VSW150	1	50A	250V AC	\$97.66
VSW210	2	10A	250V AC	\$91.24
VSW216	2	16A	250V AC	\$99.19
VSW220	2	20A	500V AC	\$101.83
VSW232	2	32A	500V AC	\$104.09
VSW240	2	40A	500V AC	\$122.08
VSW250	2	50A	500V AC	\$145.47
VSW263	2	63A	500V AC	\$186.52
VSW310	3	10A	500V AC	\$118.32
VSW316	3	16A	500V AC	\$120.79
VSW320	3	20A	500V AC	\$141.36
VSW332	3	32A	500V AC	\$160.63
VSW340	3	40A	500V AC	\$160.63
VSW350	3	50A	500V AC	\$188.90
VSW363	3	63A	500V AC	\$204.32

Operating Temp (°C)
-20 to +50
Carton Qty
Box Qty: 1 Shipper Qty: 45

STRAIGHT PLUGS



Order Code	Pins	Current Rating	Voltage	Price excl. GST	Carton Qty
VP310	3 Flat	10A	250V AC	\$64.80	Box Qty: 1 Shipper Qty: 100 (for VP310 & VP315)
VP315	3 Flat	15A	250V AC	\$118.32	
VP320	3 Round	20A	250V AC	\$142.93	Box Qty: 1 Shipper Qty: 36 (for VP320 & VP332)
VP332	3 Round	32A	250V AC	\$158.70	
VP416	4 Round	16A	500V AC	\$147.60	
VP420	4 Round	20A	500V AC	\$150.96	
VP432	4 Round	32A	500V AC	\$174.29	
VP440	4 Round	40A	500V AC	\$269.86	
VP450	4 Round	50A	500V AC	\$308.41	
VP516	5 Round	16A	500V AC	\$151.21	
VP520	5 Round	20A	500V AC	\$159.20	
VP532	5 Round	32A	500V AC	\$179.91	
VP540	5 Round	40A	500V AC	\$282.71	
VP550	5 Round	50A	500V AC	\$321.26	

INDUSTRIAL PLUGS & SOCKETS

ANGLED PLUGS



Order Code	Pins	Current Rating	Voltage	Price excl. GST
VPA320	3 Round	20A	250V AC	\$141.45
VPA332	3 Round	32A	250V AC	\$156.78
VPA416	4 Round	16A	500V AC	\$133.61
VPA420	4 Round	20A	500V AC	\$143.48
VPA432	4 Round	32A	500V AC	\$159.20
VPA440	4 Round	40A	500V AC	\$277.71
VPA450	4 Round	50A	500V AC	\$289.14
VPA516	5 Round	16A	500V AC	\$139.83
VPA520	5 Round	20A	500V AC	\$159.31
VPA532	5 Round	32A	500V AC	\$160.63
VPA540	5 Round	40A	500V AC	\$257.01
VPA550	5 Round	50A	500V AC	\$301.99

Carton Qty
Box Qty: 1 Shipper Qty: 36

CORD CONNECTORS

IP66



Order Code	Pins	Current Rating	Voltage	Price excl. GST	Carton Qty
VCS310	3 Flat	10A	250V AC	\$86.10	Box Qty: 1 Shipper Qty: 100 (for VCS310 & VCS315)
VCS315	3 Flat	15A	250V AC	\$92.52	
VCS320	3 Round	20A	250V AC	\$132.06	Box Qty: 1 Shipper Qty: 36 (for VCS320 & VCS332)
VCS332	3 Round	32A	250V AC	\$155.23	
VCS416	4 Round	16A	500V AC	\$148.05	
VCS420	4 Round	20A	500V AC	\$166.76	
VCS432	4 Round	32A	500V AC	\$191.76	
VCS440	4 Round	40A	500V AC	\$205.61	
VCS450	4 Round	50A	500V AC	\$221.03	
VCS516	5 Round	16A	500V AC	\$163.19	
VCS520	5 Round	20A	500V AC	\$174.20	
VCS532	5 Round	32A	500V AC	\$195.33	
VCS540	5 Round	40A	500V AC	\$214.60	
VCS550	5 Round	50A	500V AC	\$237.73	

LIDS



Order Code	Description	Price excl. GST
VL1	1 Module Lid	\$34.92
VL2	2 Module Lid	\$51.62

Carton Qty
Box Qty: 1 Shipper Qty: 90

BASES



Order Code	Description	Dimensions	Price excl. GST
VE1	Standard Single Module	101 x 101 x 63mm	\$40.49
VE1S	Shallow Single Module	101 x 101 x 43mm	\$26.85
VE2	Standard Two Module	198 x 101 x 63mm	\$61.76
VE2S	Shallow Two Module	198 x 101 x 43mm	\$35.87
VE3	Three Module	294 x 101 x 63mm	\$93.25
VE4	Four Module (Square)	198 x 198 x 63mm	\$122.48

Carton Qty
VE1 Box Qty: 1 VE1 Shipper Qty: 60
VE1S Box Qty: 1 VE1S Shipper Qty: 90
VE2 Box Qty: 1 VE2 Shipper Qty: 40
VE2S Box Qty: 1 VE2S Shipper Qty: 50
VE4 Box Qty: 1 VE4 Shipper Qty: 30

DIN MOUNT COVERS



Order Code	Description	Price excl. GST
VCB4	4 Module DIN Mount Cover for MCB and RCD	\$89.95
VCB8	8 Module DIN Mount Cover for MCB and RCD	\$321.26

Carton Qty
Box Qty: 1 Shipper Qty: 50

INDUSTRIAL PLUGS & SOCKETS

PLUGS

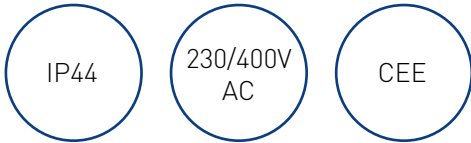

BLUE 230V AC 6H	RED 400V AC 6H
---------------------------	--------------------------

Order Code	Series	Pins	Current Rating	Price excl. GST
13502	ProTOP	3	16A	\$32.46
152	ProTOP	4	16A	\$34.42
13510	PowerTOP Xtra	5	16A	\$47.28
160	ProTOP	3	32A	\$44.12
164	ProTOP	4	32A	\$50.97
13520	PowerTOP Xtra	5	32A	\$58.00

Carton Qty
Box Qty: 1 Shipper Qty: 10

CONNECTORS

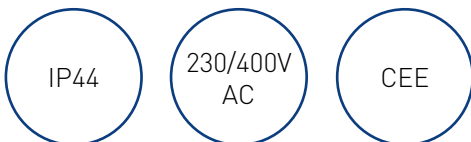

BLUE 230V AC 6H	RED 400V AC 6H
---------------------------	--------------------------

Order Code	Series	Pins	Current Rating	Price excl. GST
14502	ProTOP	3	16A	\$34.46
194	ProTOP	4	16A	\$42.16
14510	PowerTOP Xtra	5	16A	\$58.00
122	ProTOP	3	32A	\$53.53
126	ProTOP	4	32A	\$55.80
14520	PowerTOP Xtra	5	32A	\$59.79

Carton Qty
Box Qty: 1 Shipper Qty: 10

INDUSTRIAL PLUGS & SOCKETS

SURFACE MOUNTED SOCKET OUTLETS

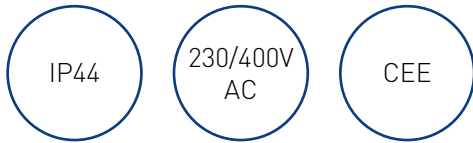

BLUE 230V AC 6H		RED 400V AC 6H			
Order Code		Pins	Current Rating	Price excl. GST	Carton Qty
101		3	16A	\$47.22	Box Qty: 1 Shipper Qty: 10
	105	4	16A	\$53.53	
1421ZA		3	32A	\$60.55	
	1425ZA	4	32A	\$66.93	

PHASE INVERTER PLUGS



BLUE 230V AC 6H		RED 400V AC 6H				
Order Code		Series	Pins	Current Rating	Price excl. GST	Carton Qty
	319	AM-TOP	5	16A	\$123.02	Box Qty: 1 Shipper Qty: 10

INDUSTRIAL PLUGS & SOCKETS

PANEL MOUNTED SOCKET OUTLETS - STRAIGHT



BLUE 230V AC 6H	RED 400V AC 6H
---------------------------	--------------------------

Order Code	Pins	Current Rating	Price excl. GST	Carton Qty
1366	3	16A	\$39.49	Box Qty: 1 Shipper Qty: 10
1385	5	16A	\$54.01	
1395	3	32A	\$55.49	

PANEL MOUNTED SOCKET OUTLETS - ANGLED



BLUE 230V AC 6H	RED 400V AC 6H
---------------------------	--------------------------

Order Code	Pins	Current Rating	Price excl. GST	Carton Qty
1463	3	16A	\$40.26	Box Qty: 1 Shipper Qty: 10
1492	3	32A	\$54.31	
1500	5	32A	\$68.24	

INDUSTRIAL PLUGS & SOCKETS

SURFACE MOUNT APPLIANCE INLETS

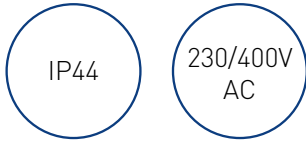

BLUE 230V AC 6H		RED 400V AC 6H	
Order Code	Pins	Current Rating	Price excl. GST
332	3	16A	\$44.91
344	3	32A	\$83.48
	354	5	\$92.78

Carton Qty
Box Qty: 1 Shipper Qty: 10

PANEL MOUNT APPLIANCE INLETS



BLUE 230V AC 6H		RED 400V AC 6H	
Order Code	Pins	Current Rating	Price excl. GST
812	3	16A	\$71.40
817	3	32A	\$93.66

Carton Qty
Box Qty: 1 Shipper Qty: 10

INDUSTRIAL PLUGS & SOCKETS

PLUGS

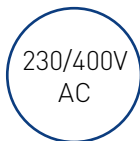

BLUE 230V AC 6H	RED 400V AC 6H
---------------------------	--------------------------

Order Code	Series	Pins	Current Rating	Price excl. GST
278	AM-TOP	3	16A	\$54.13
282	AM-TOP	4	16A	\$64.72
3809	PowerTOP	4	16A	\$105.34
288	AM-TOP	5	16A	\$73.19
290	AM-TOP	3	32A	\$123.55
294	AM-TOP	4	32A	\$121.95
3841	PowerTOP	4	32A	\$137.13
300	AM-TOP	5	32A	\$129.63
3853	PowerTOP	5	32A	\$145.82
13202	PowerTOP Xtra	3	63A	\$248.42
13206	PowerTOP Xtra	4	63A	\$253.66
13212	PowerTOP Xtra	5	63A	\$276.14
13219	PowerTOP Xtra	4	125A	\$612.66
13225	PowerTOP Xtra	5	125A	\$648.51

Carton Qty
Box Qty: 1 Shipper Qty: 10 (for 278, 282, 288, 290, 294, 300 and 3853)
Box Qty: 1 Shipper Qty: 5 (for 13202, 13206, 13212, 13219, and 13225)

INDUSTRIAL PLUGS & SOCKETS

CONNECTORS



<div style="display: flex; justify-content: space-between;"> BLUE 230V AC 6H RED 400V AC 6H </div>		Order Code	Series	Pins	Current Rating	Price excl. GST	Carton Qty
		540	AM-TOP	3	16A	\$61.99	Box Qty: 1 Shipper Qty: 10 (for 540, 544, 3871, 550, 552, 556, 562, and 3907)
		544	AM-TOP	4	16A	\$75.38	
		3871	PowerTOP	4	16A	\$114.68	
		550	AM-TOP	5	16A	\$84.32	
		552	AM-TOP	3	32A	\$118.31	
		556	AM-TOP	4	32A	\$145.59	
		3897	PowerTOP	4	32A	\$146.18	
		562	AM-TOP	5	32A	\$160.47	
		3907	PowerTOP	5	32A	\$160.47	
		14202	PowerTOP Xtra	3	63A	\$276.23	
		14206	PowerTOP Xtra	4	63A	\$288.38	Box Qty: 1 Shipper Qty: 5 (for 14202, 14206, 14212, 14219 and 14225)
		14212	PowerTOP Xtra	5	63A	\$311.24	
		14219	PowerTOP Xtra	4	125A	\$680.19	
		14225	PowerTOP Xtra	5	125A	\$703.24	

INDUSTRIAL PLUGS & SOCKETS

SURFACE MOUNTED SOCKET OUTLETS



BLUE 230V AC 6H	RED 400V AC 6H
---------------------------	--------------------------

Order Code	Pins	Current Rating	Price excl. GST	Carton Qty
9301	3	16A	\$92.54	Box Qty: 1 Shipper Qty: 5 (except for 143)
9351	3	32A	\$101.23	
	4	32A	\$102.42	Box Qty: 1 Shipper Qty: 3 (for 143)
9382	5	32A	\$101.88	
	4	63A	\$224.31	
136	5	63A	\$245.33	
	4	125A	\$693.41	
143	5	125A	\$737.11	

INDUSTRIAL
PLUGS & SOCKETS

PANEL MOUNTED SOCKET OUTLETS - ANGLED



BLUE 230V AC 6H	RED 400V AC 6H
---------------------------	--------------------------

Order Code	Pins	Current Rating	Price excl. GST
1475	3	16A	\$66.39
1502	3	32A	\$111.94
1506	4	32A	\$120.28
1551	5	32A	\$90.57
2180	3	63A	\$160.78
205	4	63A	\$177.99
209	5	63A	\$266.57
212	4	125A	\$577.42
216	5	125A	\$610.10

Carton Qty
Box Qty: 1 Shipper Qty: 10

PANEL MOUNTED SOCKET OUTLETS - STRAIGHT



BLUE 230V AC 6H	RED 400V AC 6H
---------------------------	--------------------------

Order Code	Pins	Current Rating	Price excl. GST
218	3	16A	\$66.39
230	3	32A	\$111.94
234	4	32A	\$120.28
240	5	32A	\$92.36
1264	3	63A	\$162.68
1128	5	63A	\$226.57
1461	5	125A	\$596.17

Carton Qty
Box Qty: 1 Shipper Qty: 10 (except for 1264 and 1128)
Box Qty: 1 Shipper Qty: 5 (for: 1264 and 1128)

INDUSTRIAL PLUGS & SOCKETS

SWITCHED SOCKETS - INTERLOCKED



Order Code	Pins	Current Rating	Price excl. GST
5602306G	3	16A	\$567.05
5604406G	4	32A	\$697.69
5604506G	5	32A	\$650.00
5110	4	63A	\$1114.98
5113	5	63A	\$1134.11
5691	4	125A	\$3026.40
5692	5	125A	\$3121.98

Carton Qty
Box Qty: 1 Shipper Qty: 1 (except for 5110 and 5113)
Box Qty: 1 Shipper Qty: 3 (for 5110 and 5113)

DUO WALL MOUNTED RECEPTACLE FEATURES

Designed for quick installation

Strong and lasting materials

Effective and simple operation

PANEL MOUNTED APPLIANCE INLETS



Order Code	Pins	Current Rating	Price excl. GST
826	3	16A	\$79.85
831	3	32A	\$136.95
832	4	32A	\$142.43
834	5	32A	\$123.62
836	3	63A	\$225.03
3658	5	63A	\$261.23
3583	4	125A	\$624.39
1983	5	125A	\$649.88

Carton Qty
Box Qty: 1 Shipper Qty: 10 (except for 3658 and 3583)
Box Qty: 1 Shipper Qty: 5 (for 3658)

INDUSTRIAL PLUGS & SOCKETS

CEE PLUG & SOCKET ACCESSORIES

Order Code	Description	Price excl. GST
40784	CEE Plug Protective Cover 16A, 3 Pins	\$65.14
40841	CEE Plug Protective Cover 32A, 3 or 4 Pins	\$75.75
40786	CEE Plug Protective Cover 32A, 5 Pins	\$82.65
40787	CEE Plug Protective Cover 63A, 3, 4, or 5 Pins	\$82.65
40788	CEE Plug Protective Cover 125A, 3, 4, or 5 Pins	\$115.99
41416	Plug Guard Locking Feature	\$20.24
41470	Spare Connector Red Lid + Rivet and Spring	\$61.75



40784



41416



40787

CONTAINER PLUG AND CONNECTOR



IP67 400V AC 3H Earth position



RED 400V AC 3H						Carton Qty
Order Code	Series	Description	Pins	Current Rating	Price excl. GST	
2175	AM-TOP	Plug	4	32A	\$75.38	Box Qty: 1 Shipper Qty: 10
2177	AM-TOP	Connector	4	32A	\$89.44	
2176	AM-TOP	PE-Inverter Plug	4	32A	POA	

2176 CONTAINER PLUG WITH PE INVERTER FEATURES

Swap between Container Sockets and Standard sockets easily using a screwdriver	No need to change the Plug to switch between Container and standard Sockets	Changes between a 3H and 6H earth position without rewiring
--	---	---

CONTAINER SOCKETS

IP67 400V AC 3H Earth position



RED 400V AC 3H					Carton Qty
Order Code	Description	Pins	Current Rating	Price excl. GST	
9562	Surface Mount Socket Outlet	4	32A	\$98.10	Box Qty:1 Shipper Qty: 5 (for 9562)
5792	Switched Socket	4	32A	\$726.34	Box Qty: 1 Shipper Qty: 1 (for 5792/5704403G)
2123	Panel Mount Socket Outlet	4	32A	\$119.98	
5704403G	Switched Socket	4	32A	\$726.34	Box Qty:1 Shipper Qty: 10 (for 2123)

INDUSTRIAL PLUGS & SOCKETS

NATO PLUGS



NATO GREEN	
BLUE 230V AC 6H	RED 400V AC 6H

Order Code	Series	Pins	Current Rating	Price excl. GST
24660	AM-TOP	3	16A	\$156.96
24670	AM-TOP	5	16A	\$161.72
24760	AM-TOP	3	32A	\$200.01
24770	AM-TOP	5	32A	\$194.36
24870	AM-TOP	5	63A	\$340.60

Carton Qty
Box Qty: 1 Shipper Qty: 10

NATO CONNECTORS



NATO GREEN	
BLUE 230V AC 6H	RED 400V AC 6H

Order Code	Series	Pins	Current Rating	Price excl. GST
24675	AM-TOP	3	16A	\$183.70
24685	AM-TOP	5	16A	\$198.59
24775	AM-TOP	3	32A	\$228.42
24785	AM-TOP	5	32A	\$228.60
24885	AM-TOP	5	63A	\$403.78

Carton Qty
Box Qty: 1 Shipper Qty: 10

NATO PANEL MOUNT SOCKET OUTLET - STRAIGHT



NATO GREEN	
BLUE 230V AC 6H	RED 400V AC 6H

Order Code	Pins	Current Rating	Price excl. GST
22928	3	16A	\$157.91
23293	3	32A	\$202.58
20459	5	32A	\$193.64

Carton Qty
Box Qty: 1

INDUSTRIAL PLUGS & SOCKETS

T-WREX SOCKET OUTLET

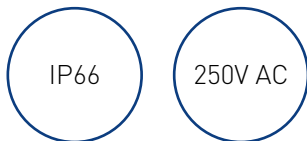

Order Code	Pins	Current Rating	Price excl. GST
VS3/6C	3 Round (CEE)	16A	\$90.92

Operating Temp (°C)
-20 to +50
Carton Qty
Box Qty: 1 Shipper Qty: 45

T-WREX COMBINATION SWITCHED SOCKETS



Order Code	Pins	Current Rating	Price excl. GST
VC3/6C	3 Round (CEE)	16A	\$227.80

Operating Temp (°C)
-20 to +50
Carton Qty
Box Qty: 1 Shipper Qty: 30

CARAVAN KIT



**BLUE
230V AC 6H**

Order Code	Description	Pins	Current Rating	Price excl. GST
CK01	Plug (13502), Connector (14502), and Inlet (847ZA)	3	16A	\$124.70

Carton Qty
Box Qty: 1 Shipper Qty: 1

INDUSTRIAL
PLUGS & SOCKETS

CONNECTORS

IP44
Except 540

230V AC



BLUE
230V AC 6H

Order Code	Series	Description	Pins	Current Rating	Price excl. GST
14502	ProTOP	Straight	3	16A	\$34.27
1438	-	Angled	3	16A	\$96.10
540	AM-TOP	Straight (IP67)	3	16A	\$61.99
122	ProTOP	Straight	3	32A	\$53.53

Carton Qty
Box Qty: 1 Shipper Qty: 10

SURFACE MOUNTED CARAVAN INLET/ SOCKET

IP44

230V AC



BLUE
230V AC 6H

Order Code	Description	Pins	Current Rating	Price excl. GST
847ZA	Inlet	3	16A	\$66.26
101	Socket	3	16A	\$47.22

Carton Qty
Box Qty: 1 Shipper Qty: 10

PANEL MOUNTED SOCKET OUTLETS

IP44

230V AC



BLUE
230V AC 6H

Order Code	Description	Pins	Current Rating	Price excl. GST
1366	Straight	3	16A	\$39.49
1463	Angled	3	16A	\$40.26
1395	Straight	3	32A	\$52.85
1492	Angled	3	32A	\$54.31

Carton Qty
Box Qty: 1 Shipper Qty: 10

INDUSTRIAL
PLUGS & SOCKETS

SUPPLY LEADS



BLUE
230V AC 6H

Order Code	Description	Pins	Current Rating	Price excl. GST
CL1610	10m, comes with 14502 and 13502	3	16A	\$192.60
CL1615	15m, comes with 14502 and 13502	3	16A	\$237.60
CL1620	20m, comes with 14502 and 13502	3	16A	\$272.40

Carton Qty
Box Qty: 1 Shipper Qty: 1

Other lengths and configurations available on request

SUPPLY LEADS



BLUE
230V AC 6H

Order Code	Description	Pins	Current Rating	Price excl. GST
CSA10	1.2m Caravan Supply Adaptor c/w 10A 6kA MCB	3	10A	\$148.02

Carton Qty
Box Qty: 1 Shipper Qty: 1

INDUSTRIAL
PLUGS & SOCKETS

PLUGS

IP44
Except 278

230/400V
AC



BLUE
230V AC 6H

Order Code	Series	Description	Pins	Current Rating	Price excl. GST	Carton Qty
13502	ProTOP	Straight	3	16A	\$32.46	Box Qty: 1 Shipper Qty: 10
278	AM-TOP	Straight (IP67)	3	16A	\$54.13	
160	ProTOP	Straight	3	32A	\$44.12	

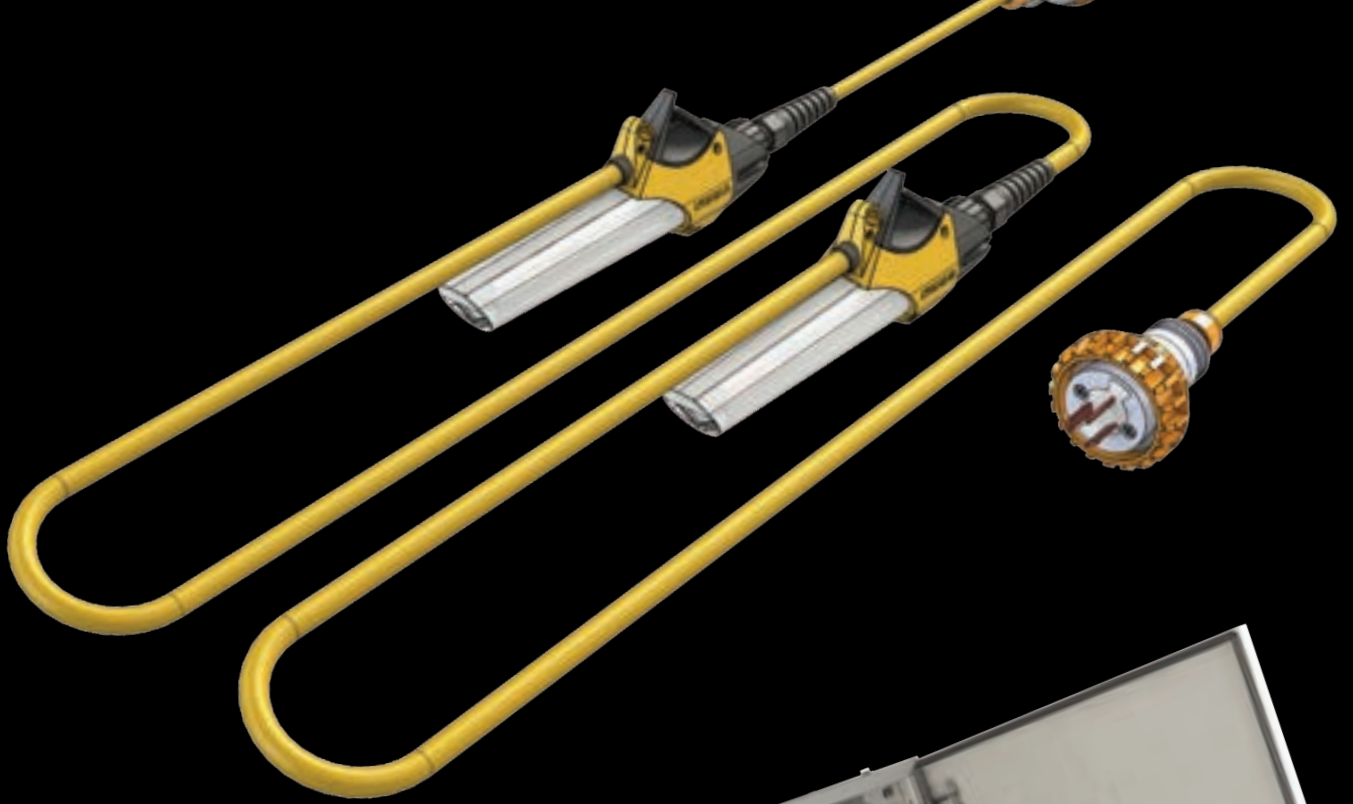

VYNCO

ONBOARD PROGRAMME

Vynco has a long history designing and manufacturing switchboard systems, ranging from complex 4000A switchboards to smaller residential units.

The team is comprised of specialist engineers who have developed a range of switchboards that will suit most mid-range applications. This range reduces the need for custom designing and quoting, reducing the wait time for customers.

NEW



Robust steel cabinets

Made in New Zealand

Onboard Switchboards	202
Chassis	210
Onboard Switchboard Accessories	211
Power Boards	217
Power Supply Units	218
Interconnecting Leads	221
Portable Lights	222

COMMERCIAL POWER

DIN RAIL MCB BOARDS

Robust steel construction



MADE IN NZ

SB16554

Order Code	Ways	Rows	Box Dimensions (H x W x D)	Price excl. GST	Material
SB16218	18	1	250 x 500 x 165mm	POA	1.2mm Powder Coated Steel
SB16554	54	3	500 x 500 x 165mm	POA	
SB16772	72	4	750 x 500 x 165mm	POA	
SB16108	108	6	1000 x 500 x 165mm	POA	
SB25218	18	1	250 x 500 x 250mm	POA	
SB25554	54	3	500 x 500 x 250mm	POA	
SB25772	72	4	750 x 500 x 250mm	POA	
SB25108	108	6	1000 x 500 x 250mm	POA	

Comes with DIN rail, cover plate, a tunnel bar assembly and NL3 neutral units, 2x aluminium gland plates and a standard handle.

ENCLOSURES

Robust steel construction



MADE IN NZ

SB16250

Order Code	Box Dimensions (H x W x D)	Price excl. GST	Material
SB16250	250 x 500 x 165mm	POA	1.2mm Powder Coated Steel
SB16500	500 x 500 x 165mm	POA	
SB16750	750 x 500 x 165mm	POA	
SB16000	1000 x 500 x 165mm	POA	
SB25250	250 x 500 x 250mm	POA	
SB25500	500 x 500 x 250mm	POA	
SB25750	750 x 500 x 250mm	POA	
SB25000	1000 x 500 x 250mm	POA	

Comes with 2x aluminium gland plates and standard handle.

COMMERCIAL POWER



DUCT



Order Code	Box Dimensions (H x W x D)	Price excl. GST
SB16520	500 x 250 x 165	POA
SB16720	750 x 250 x 165	POA
SB16120	1000 x 250 x 165	POA
SB25520	500 x 250 x 250	POA
SB25720	750 x 250 x 250	POA
SB25120	1000 x 250 x 250	POA

Material
1.2mm Powder Coated Steel

Comes with 2x aluminium gland plates and 3mm insert lock.

3 PHASE MCB BOARDS

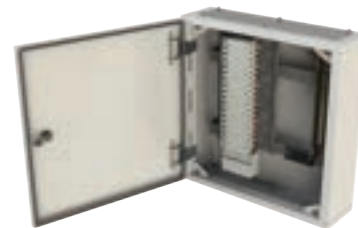
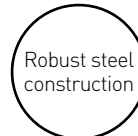

SB16536

Order Code	Ways	Triple Pole	Box Dimensions (H x W x D)	Price excl. GST
SB16518	18	6	500 x 500 x 165mm	POA
SB16524	24	8	500 x 500 x 165mm	POA
SB16536	36	12	500 x 500 x 165mm	POA
SB16736	36	12	750 x 500 x 165mm	POA
SB16748	48	16	750 x 500 x 165mm	POA
SB16760	60	20	750 x 500 x 165mm	POA
SB16148	48	16	1000 x 500 x 165mm	POA
SB16160	60	20	1000 x 500 x 165mm	POA
SB16172	72	24	1000 x 500 x 165mm	POA
SB25518	18	6	500 x 500 x 250mm	POA
SB25524	24	8	500 x 500 x 250mm	POA
SB25536	36	12	500 x 500 x 250mm	POA
SB25736	36	12	750 x 500 x 250mm	POA
SB25748	48	16	750 x 500 x 250mm	POA
SB25760	60	20	750 x 500 x 250mm	POA
SB25148	48	16	1000 x 500 x 250mm	POA
SB25160	60	20	1000 x 500 x 250mm	POA
SB25172	72	24	1000 x 500 x 250mm	POA

Material
1.2mm Powder Coated Steel

Comes with pan assembly, cover plate, tunnel bar assembly, 2x aluminium gland plates and standard handle.

COMMERCIAL POWER

PREMADE SWITCHBOARDS - FORME 100 SERIES

Robust steel construction



SB752

SB501: 500H x 1000W 24 Way + 3P 100A Isolator Right Control Space

Order Code	Dimensions (H x W x D)	Chassis Pan assembly	Isolator	Control Space (H x W)	Price excl. GST
SB501	500 x 1000 x 165mm	24 way	100A	On right side 500 x 500mm	POA
SB5011	1000 x 500 x 165mm	24 way	100A	On bottom 500 x 500mm	POA
SB5012	500 x 1000 x 165mm	24 way	100A	On left side 500 x 500mm	POA
SB5013	1000 x 500 x 165mm	24 way	100A	On top 500 x 500mm	POA

SB502: 500H x 1000W 24 Way + 3P 100A Isolator with Right Meter Space

Order Code	Dimensions (H x W x D)	Chassis Pan assembly	Isolator	Meter Space (H x W)	Price excl. GST
SB502	500 x 1000 x 165mm	24 way	100A	On right side 500 x 500mm	POA
SB5021	1000 x 500 x 165mm	24 way	100A	On top 500 x 500mm	POA
SB5022	500 x 1000 x 165mm	24 way	100A	On left side 500 x 500mm	POA
SB5023	1000 x 500 x 165mm	24 way	100A	On bottom 500 x 500mm	POA

Comes wired for three phase meter, meter panel and clear meter cover.

SB502B: 500H x 1000W 24 Way + 3P 63A MCB with Right Meter Space

Order Code	Dimensions (H x W x D)	Chassis Pan assembly	MCB	Meter Space (H x W)	Price excl. GST
SB502B	500 x 1000 x 165mm	24 way	63A	On right side 500 x 500mm	POA
SB502B1	1000 x 500 x 165mm	24 way	63A	On top 500 x 500mm	POA
SB502B2	500 x 1000 x 165mm	24 way	63A	On left side 500 x 500mm	POA
SB502B3	1000 x 500 x 165mm	24 way	63A	On bottom 500 x 500mm	POA

Comes wired for three phase meter, meter panel and clear meter cover.

SB503: 500H x 1000W 54 Way DIN with Right Control Space

Order Code	Dimensions (H x W x D)	Din Rail	Control Space (H x W)	Price excl. GST
SB503	500 x 1000 x 165mm	54 way	On right side 500 x 500mm	POA
SB5031	500 x 1000 x 165mm	54 way	On left side 500 x 500mm	POA
SB5032	1000 x 500 x 165mm	54 way	On top 500 x 500mm	POA
SB5033	1000 x 500 x 165mm	54 way	On bottom 500 x 500mm	POA

SB751: 750H x 1000W 48 Way + 3P 100A Isolator with Left Control Space

Order Code	Dimensions (H x W x D)	Chassis Pan assembly	Isolator	Control Space (H x W)	Price excl. GST
SB751	750 x 1000 x 165mm	48 way	100A	On left side 750 x 500mm	POA
SB7511	750 x 1000 x 165mm	48 way	100A	On right side 750 x 500mm	POA

SB752: 750H x 1000W 48 Way + 160A MCCB with Control Space

Order Code	Dimensions (H x W x D)	Chassis Pan assembly	MCCB	Control Space (H x W)	Price excl. GST
SB752	750 x 1000 x 165mm	48 way	160A	On left side 250 x 500mm	POA

SB753: 750H x 1000W 48 Way + 200A Isolator with Control Space

Order Code	Dimensions (H x W x D)	Chassis Pan assembly	Isolator	Control Space (H x W)	Price excl. GST
SB753	750 x 1000 x 165mm	48 way	200A	On left side 250 x 500mm	POA

SB101: 1000H x 750W 24TP – 72 Way + 3P 100A Isolator with Right Cable Duct Space

Order Code	Dimensions (H x W x D)	Chassis Pan assembly	Isolator	Duct Space (H x W)	Price excl. GST
SB101	1000 x 750 x 165mm	72 way	100A	On right side 1000 x 250mm	POA
SB1011	1000 x 750 x 165mm	72 way	100A	On left side 1000 x 250mm	POA

PREMADE SWITCHBOARDS - FORME 200 SERIES

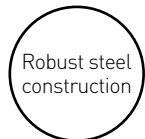

SB121: 1250H x 500W 60 Way + 3P 100A Isolator with Bottom Meter Space

Order Code	Dimensions (H x W x D)	Chassis Pan assembly	Isolator	Meter Space (H x W)	Price excl. GST
SB121	1250 x 500 x 250mm	60 way	100A	On bottom 500 x 500mm	POA
SB1211	1250 x 500 x 250mm	60 way	100A	On top 500 x 500mm	POA

Comes wired for three phase meter, meter panel and clear meter cover.

SB121B: 1250H x 500W 60 Way + 3P 63A MCB with Bottom Meter Space

Order Code	Dimensions (H x W x D)	Chassis Pan assembly	MCB	Meter Space (H x W)	Price excl. GST
SB121B	1250 x 500 x 250mm	60 way	63A	On bottom 500 x 500mm	POA
SB121B1	1250 x 500 x 250mm	60 way	63A	On top 500 x 500mm	POA

Comes wired for three phase meter, meter panel and clear meter cover.

SB122: 1250H x 750W 60 Way + 200A MCCB with Right Cable Duct Space

Order Code	Dimensions (H x W x D)	Chassis Pan assembly	MCCB	Duct Space (H x W)	Price excl. GST
SB122	1250 x 750 x 250mm	60 way	200A	On right side 1250 x 250mm	POA
SB1221	1250 x 750 x 250mm	60 way	200A	On left side 1250 x 250mm	POA

SB123: 1250H x 750W 60 Way + 3P 100A Isolator with Bottom Control Space and Right Cable Duct Space

Order Code	Dimensions (H x W x D)	Chassis Pan assembly	Isolator	Control Space (H x W)	Duct Space (H x W)	Price excl. GST
SB123	1250 x 750 x 250mm	60 way	100A	On bottom 500 x 500mm	On right side 1250 x 250mm	POA
SB1231	1250 x 750 x 250mm	60 way	100A	On bottom 500 x 500mm	On left side 1250 x 250mm	POA

COMMERCIAL POWER

SB124: 1250H x 750W 60 Way + 3P 100A Isolator with Bottom Meter Space and Right Cable Duct Space

Order Code	Dimensions (H x W x D)	Chassis Pan assembly	Isolator	Meter Space (H x W)	Duct Space (H x W)	Price excl. GST
SB124	1250 x 750 x 250mm	60 way	100A	On bottom 500 x 500mm	On right side 1250 x 250mm	POA
SB1241	1250 x 750 x 250mm	60 way	100A	On bottom 500 x 500mm	On left side 1250 x 250mm	POA

Comes wired for three phase meter, meter panel and clear meter cover.

SB124B: 1250H x 750W 60 Way + 3P 63A MCB with Bottom Meter Space and Right Cable Duct Space

Order Code	Dimensions (H x W x D)	Chassis Pan assembly	MCB	Meter Space (H x W)	Duct Space (H x W)	Price excl. GST
SB124B	1250 x 750 x 250mm	60 way	63A	On bottom 500 x 500mm	On right side 1250 x 250mm	POA
SB124B1	1250 x 750 x 250mm	60 way	63A	On bottom 500 x 500mm	On left side 1250 x 250mm	POA

Comes wired for three phase meter, meter panel and clear meter cover.

SB125: 1250H x 750W 60 Way + 200A Isolator with Control Space and Right Cable Duct Space

Order Code	Dimensions (H x W x D)	Chassis Pan assembly	Isolator	Control Space (H x W)	Duct Space (H x W)	Price excl. GST
SB125	1250 x 750 x 250mm	60 way	200A	250 x 500mm	On right side 1250 x 250mm	POA
SB1251	1250 x 750 x 250mm	60 way	200A	250 x 500mm	On left side 1250 x 250mm	POA

SB151: 1500H x 750W 60 Way + 200A Isolator with Control Space and Right Cable Duct Space

Order Code	Dimensions (H x W x D)	Chassis Pan assembly	Isolator	Control Space (H x W)	Duct Space (H x W)	Price excl. GST
SB151	1500 x 750 x 250mm	60 way	200A	500 x 500mm	On right side 1500 x 250mm	POA
SB1511	1500 x 750 x 250mm	60 way	200A	500 x 500mm	On left side 1500 x 250mm	POA

SB152: 1500H x 1250W 60 Way + 200A MCCB with CT Chamber, Control, Meter and Middle Cable Duct Space

Order Code	Dimensions (H x W x D)	Chassis Pan assembly	MCCB	Meter Space (H x W)	Control Space (H x W)	CT Chamber (H x W)	Duct Space (H x W)	Price excl. GST
SB152	1500 x 1250 x 250mm	60 way	200A	500 x 500mm	750 x 500mm	250 x 500mm	1500 x 250mm	POA

Comes with clear cover for the meter panel.

SB153: 1500H x 1250W 2x 60 Way + 200A MCCB with CT Chamber, Meter Space and Middle Cable Duct Space

Order Code	Dimensions (H x W x D)	Chassis Pan assembly	MCCB	Meter Space (H x W)	CT Chamber (H x W)	Duct Space (H x W)	MCCB Space	Price excl. GST
SB153	1500 x 1250 x 250mm	2x 60 way	200A	500 x 500mm	250 x 500mm	1500 x 250mm	750 x 500	POA
SB153B	1500 x 1250 x 250mm	2x 60 way	160A	500 x 500mm	250 x 500mm	1500 x 250mm	750 x 500	POA

Comes with clear cover for the meter panel.

SB154: 1500H x 1250W 60 Way + 72 Way DIN + 200A MCCB with CT Chamber, Meter Space and Middle Cable Duct Space

Order Code	Dimensions (H x W x D)	Chassis Pan assembly	DIN Rail	MCCB	Meter Space (H x W)	CT Chamber (H x W)	Duct Space (H x W)	Price excl. GST
SB154	1500 x 1250 x 250mm	60 way	72 way (18W x 4)	200A	500 x 500mm	250 x 500mm	1500 x 250mm	POA
SB154B	1500 x 1250 x 250mm	60 way	72 way (18W x 4)	160A	500 x 500mm	250 x 500mm	1500 x 250mm	POA

Comes with clear cover for the meter panel.

SB155: 1500H x 1500W 24 Way including 200A MCCB with 18 Way DIN Distribution, Control, Meter and Middle Cable Duct Space

Order Code	Dimensions (H x W x D)	Chassis Pan assembly	DIN Rail	MCCB	Meter Space (H x W)	Control Space (H x W)	Duct Space (H x W)	Price excl. GST
SB155	1500 x 1500 x 250mm	24 way	18 way	200A	750 x 750mm (2x)	250 x 500mm	1500 x 250mm	POA

Comes with clear cover for the meter panel.

CHANGE-OVER SWITCH PANEL



- IP42
- Robust steel construction
- Supplied with 4P 63A C/O Switch

Order Code	Dimensions (H x W x D)	Change-over Switch	Price excl. GST
SB521	250 x 500 x 165mm	4P 63A	POA
SB522	250 x 750 x 165mm	4P 63A	POA
SB523	250 x 500 x 250mm	4P 63A	POA
SB524	250 x 750 x 250mm	4P 63A	POA

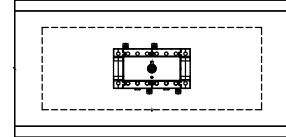

SB521

SOLAR GRID PROTECTION PANEL



- IP42
- Robust steel construction
- Made in NZ
- Supplied with 4P 125A AC/DC Contactor and 3P 10A MCB

Order Code	Dimensions (H x W x D)	Solar Grid Protection	Price excl. GST
SB555	500 x 500 x 250mm	30kW - 85kW	POA

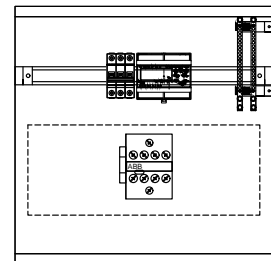

SB555

COMMERCIAL POWER

CHASSIS



ETB01B12

Order Code	Ways	TP	Dimensions (LxWxD)	Price excl. GST
ETB01B12VYN	12	4	182.7 x 192.5 x 63mm	\$250.85
ETB01B18VYN	18	6	236.3 x 192.5 x 63mm	\$270.93
ETB01B24VYN	24	8	290.3 x 192.5 x 63mm	\$328.62
ETB01B36VYN	36	12	398.3 x 192.5 x 63mm	\$416.01
ETB01B48VYN	48	16	506.3 x 192.5 x 63mm	\$532.41
ETB01B54VYN	54	18	560.3 x 192.5 x 63mm	\$610.73
ETB01B60VYN	60	20	614.3 x 192.5 x 63mm	\$677.10
ETB01B72VYN	72	24	722.3 x 192.5 x 63mm	\$812.18

Carton Qty
Box Qty: 1

Suitable: For all FORME range

MOUNTING BRACKETS



Order Code	Cabinet Width	Cabinet Depth	Price excl. GST
SBUM5025	500	250	\$43.44
SBUM7525	750	250	\$57.42
SBUM5015	500	165	\$12.10
SBUM7515	750	165	\$15.38

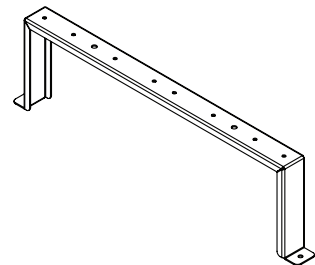

SBUM5025

Suitable: For all chassis sizes of FORME range

ONBOARD RANGE WIRING KITS

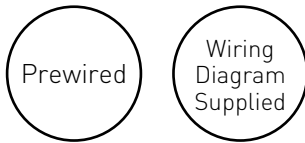

Order Code	Description	Comes With	Price excl. GST
SBCTK	CT Wiring Kit. Comes with all you need to connect current transformers in your OnBoard Switchboard. Compliant to Wells CT wiring standards.	3 x S1 2.5mm red white blue cables 2m 3 x S2 2.5mm red white blue cables 2m 3 x 6.0mm red white blue cables 2m Standard CT wiring diagram	\$83.20
SBMK	Meter Wiring Kit - 63A One kit is able to wire three single phase meters or one three phase meter.	1 x 10mm red cable 2.5m* 1 x 10mm white cable 2.5m* 1 x 10mm blue cable 2.5m* 3 x loose ferrules *Ferrule on one end, other end unferruled	\$135.20

ONBOARD RANGE LIGHTING KITS

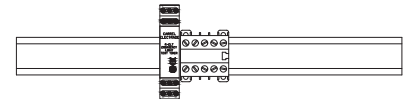

Order Code	Description	Control	Comes With	Price excl. GST
SBELTK	Emergency Lighting Kit Supplied on DIN Rail.	Up to 4 circuits switched	230V Emergency Timer and 4P 25A Contactor	\$422.90

ONBOARD RANGE TUNNEL BAR ASSEMBLIES

Order Code	Ways	Amps	Maximum Cable Size	Stud Size	Price excl. GST
MB50700	12 Way	100A	16mm ²	M6	\$108.20
MB50701	18 Way	100A	16mm ²	M6	\$118.45
MB50702	24 Way	100A	16mm ²	M6	\$133.25
MB50703	36 Way	100A	16mm ²	M6	\$164.15
MB50725	24 Way	250A	50mm ²	M8	\$218.82
MB50726	36 Way	250A	50mm ²	M8	\$269.22
MB50727	48 Way	250A	50mm ²	M8	\$319.57
MB50728	60 Way	250A	50mm ²	M8	\$374.18



MB50700

ONBOARD RANGE STUD BAR

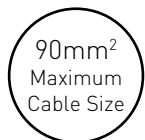

Order Code	Ways	Amps	Price excl. GST
SB062025	6 Way	200A	\$187.00
SB102025	10 Way	200A	\$229.00
SB064025	6 Way	400A	\$200.20
SB104025	10 Way	400A	\$252.50



SB062025

COMMERCIAL POWER

ONBOARD RANGE BLANKS

Order Code	Description	Lengths	Colour	Price excl. GST
V8013	Modular Blanks	6 Way, Pole Filler	White	\$4.02



V8013

ONBOARD RANGE BRACKETS

Order Code	Description	Price excl. GST
SBBRMP00	Masking Panel Bracket	\$1.82
SBBRWM00	Wall Mount Bracket	\$3.70
SBBRL000	"L" Brackets	\$3.45



SBBRMP00

ONBOARD RANGE HANDLES

Order Code	Description	Price excl. GST
MB50601SC	Wing knob sec. lock	\$88.00
SB50602	3mm Bit Lock	\$21.75
SB50604	Lever Handle	\$13.50
SB50605	Security Lock and 2x Keys (144)	\$21.75



SB50605

ONBOARD RANGE COMBINATION CHASSIS/DIN MASKING PANELS

Material
PVC

Order Code	Dimensions (mm)	To Suit (Chassis)	To Suit (DIN)	Price excl. GST
SBCC7550	750H x 500W	60 Way	18 Way	\$68.00
SBCC1050	1000H x 500W	72 Way	18 Way	\$81.00



SBCC1050

ONBOARD RANGE DIN RAIL MASKING PANELS

Material
PVC

Order Code	Dimensions (mm)	To Suit (DIN)	Price excl. GST
SBDC2550	250H x 500W	18 Way	\$16.50
SBDC5050	500H x 500W	54 Way	\$40.50
SBDC7550	750H x 500W	72 Way	\$68.00
SBDC1050	1000H x 500W	108 Way	\$85.00



SBDC2550

COMMERCIAL
POWER

ONBOARD RANGE OFFSET CHASSIS MASKING PANELS

Material
PVC

Order Code	Dimensions (mm)	To Suit (Chassis)	Price excl. GST
SBOC5050	500H × 500W	36 Way	\$41.00
SBOC5075	500H × 750W	36 Way	\$68.00
SBOC7550	750H × 500W	60 Way	\$68.00
SBOC7575	750H × 750W	60 Way	\$130.00
SBOC1050	1000H × 500W	72 Way	\$81.00
SBOC1075	1000H × 750W	72 Way	\$131.00



SBOC1050

ONBOARD RANGE PLAIN MASKING PANELS

Material
PVC

Order Code	Dimensions (mm)	Price excl. GST
SBPC2550	250H × 500W	\$22.83
SBPC5050	500H × 500W	\$40.50
SBPC7550	750H × 500W	\$65.43
SBPC1050	1000H × 500W	\$77.00



SBPC7550

COMMERCIAL
POWER

ONBOARD RANGE GEAR TRAYS

Material
Pertinax

Order Code	Dimensions (mm)	Price excl. GST
SBGT2550	250H x 500W	\$55.00
SBGT5025	500H x 250W	\$56.00
SBGT5050	500H x 500W	\$71.01
SBGT7550	750H x 500W	\$187.00
SBGT7575	750H x 750W	\$293.00
SBGT1050	1000H x 500W	\$258.00

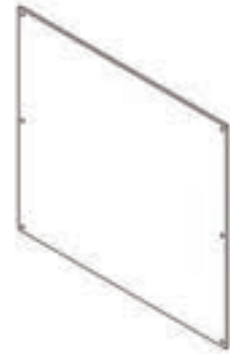

SBGT5050

ONBOARD RANGE CLEAR PANELS

Material
Polycarbonate

Order Code	Dimensions (mm)	Price excl. GST
SBCP1050	1000H x 500W	\$225.00
SBCP1075	1000H x 750W	\$282.00
SBCP2550	250H x 500W	\$95.00
SBCP2575	250H x 750W	\$108.00
SBCP5050	500H x 500W	\$128.00
SBCP5075	500H x 750W	\$157.00
SBCP7550	750H x 500W	\$157.00
SBCP7575	750H x 750W	\$217.00

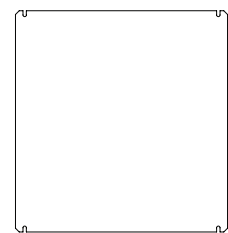

SBCP5050

COMMERCIAL
POWER

4 OUTLET POWER BOARD

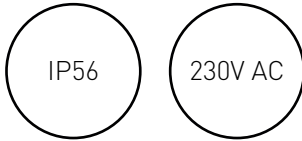

Order Code	Outlets	Configuration	Price excl. GST
NOMAD4	10A	Auto Socket AS/NZ 2P + E	\$430.00

Complies with AS/NZS 3012 & AS/NZS 3190

Carton Qty
Box Qty: 1

6 OUTLET POWER BOARD

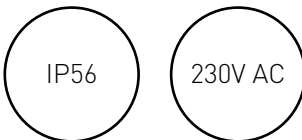

Order Code	Outlets	Configuration	Price excl. GST
NOMAD6	10A	Auto Socket AS/NZ 2P + E	\$752.50

Complies with AS/NZS 3012 & AS/NZS 3190

Carton Qty
Box Qty: 1

32A POWER SUPPLY UNIT



Order Code	Weight	Input	Price excl. GST
N32	16kg	1 x 32A, 400V, 3PH + E+N, IEC	\$2008.91

Carton Qty

Box Qty: 1

CONTENTS

Outlets	Quantity	Configuration	Voltage
32A*	1	IEC, 3PH + E+N	400V AC
16A	1	IEC, 2P + E (RCD Protected)	230V AC
10A AUTOSOCKET	10	AS/NZ, 2P + E (RCD Protected)	230V AC

Complies with AS/NZS 3190:2011 & AS/NZS 3012:2010
 *Interconnection outlet

63A POWER SUPPLY UNIT



Order Code	Weight	Input	Price excl. GST
N63	17kg	1 x 63A, 400V, 3PH+E+N	\$2277.66

Carton Qty

Box Qty: 1

CONTENTS

Outlets	Quantity	Configuration	Voltage
63A*	1	IEC, 3PH + E+N	400V AC
32A*	1	IEC, 3PH + E+N	400V AC
32A	1	AS/NZ, 3P + E+N (RCD Protected)	400V AC
16A	1	IEC, 2PH+E (RCD Protected)	230V AC
10A AUTOSOCKET	4	AS/NZ, 2P+E (RCD Protected)	230V AC

Complies with AS/NZS 3190:2011 & AS/NZS 3012:2010
 *Interconnection outlet

COMMERCIAL POWER

POWER DISTRIBUTION UNIT

IP65 Cabinet	IP66 External Sockets	Mobile Rigging Frame
IK10	Weather Resistant	Crane Hooks Available on Request



Order Code	Input	Specifications	Price excl. GST	Carton Qty
NOMAD250	250A, 400V AC, 3PH+E+N	250A MCCB 3x 63A IEC 5 Pin Sockets (MCB Protected) 3x 32A IEC 5 Pin Sockets (MCB Protected) 4x 15A 3 Flat Pin Sockets (RCD/MCB Protected) 2x 16A 3 IEC 3 Pin Sockets (RCD/MCB Protected)	\$8367.80	Box Qty: 1

Customisation options available from 250A to 800A with any configuration of outlets.
Metering options also available.

POWER UNIT MOUNTING STAND

Powder Coated Steel

N63/N32 Comfortable working height

Assists with raising leads off the floor, can be combined with the hang-over bar for further support of cables



Order Code	Description	Price excl. GST
NOMADK2	Powder Coated Steel K2 Stand (without Trays)	\$817.00
NOMADK2A	Powder Coated Steel K2 Stand with 2x Aluminium Trays	\$1128.75
NOMADK2HB	Cable Hangover Bar	\$193.50
FOR USE WITH		
N63	N63 Power Supply Unit	\$2277.66
N32	N32 Power Supply Unit	\$2008.91
NOMAD6	NOMAD6 Power Board	\$752.50

Carton Qty
Box Qty: 1

Hanging and mounting options for Nomad6 Customisation options available.

FEATURES



Designed and engineered in NZ



Robust design suitable for use on building and construction sites



Includes securing points for mounted units & cable tie points to secure extension leads

COMMERCIAL POWER

INTERCONNECTING LEADS



NL3220

Order Code	Length	Amperage	Voltage	Plug Type	Cable	Price excl. GST	Carton Qty
NL1010	10m	10A	250V AC	3 Pin - Flat	2.5mm ² , 3 Core	POA	Box Qty: 1
NL1020	20m	10A	250V AC	3 Pin - Flat	2.5mm ² , 3 Core	POA	
NL3210	10m	32A	400V AC	IEC 60309	6mm ² , 3PH+E+N	POA	
NL3220	20m	32A	400V AC	IEC 60309	6mm ² , 3PH+E+N	POA	
NL3230	30m	32A	400V AC	IEC 60309	6mm ² , 3PH+E+N	POA	
NL3240	40m	32A	400V AC	IEC 60309	6mm ² , 3PH+E+N	POA	
NL6310	10m	63A	400V AC	IEC 60309	16mm ² , 3PH+E+N	POA	
NL6320	20m	63A	400V AC	IEC 60309	16mm ² , 3PH+E+N	POA	
NL6330	30m	63A	400V AC	IEC 60309	16mm ² , 3PH+E+N	POA	
NL6340	40m	63A	400V AC	IEC 60309	16mm ² , 3PH+E+N	POA	

SABRE - TEMPORARY SITE LIGHTING

IK08

IP65

230 to 240V AC

Outdoor Suitable

LED's provide reliable high light output



Order Code	Connection	Wattage	Lumen Output	No. of Lights	Cord Length	Price excl. GST	
NOMADL10C2A	10A, 3 Flat Pin Plug and Connector	Single Fitting - 9W Chain of 2 - 18W	1300lm per lamp	2	2.5m	\$241.88	Carton Qty: Box Qty: 1
NOMADL10	16A, 3 Round Pin Plug and Connector	Single Fitting - 9W Chain of 10 - 90W	1300lm per lamp	10	2.5m	\$900.00	
NOMADL10A	10A, 3 Flat Pin Plug and Connector	Single Fitting - 9W Chain of 10 - 90W	1300lm per lamp	10	2.5m	\$839.90	

Complies with AS/NZS 60598.1 & AS/NZS 60598.2.20
Plug and inter-connection options available.

FEATURES



Designed and engineered in NZ



Robust design suitable for use on building and construction sites

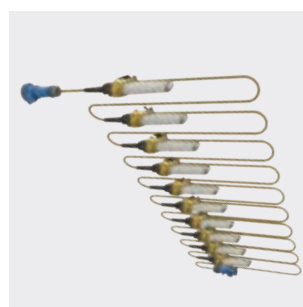

Up to 60x lights

**Australian
New Zealand
Standards**

Compliant to
AS/NZS 60598.1 &
AS/NZS 60598.2.20







COMMERCIAL POWER

IK/IP Rating Guide	224
Outdoor Suitable Enclosures	225
Notes	226
Standards Certification	226
Notes	231



IK RATING GUIDE

IK Rating shows protection against mechanical impact.







IK00	IK01-05	IK06	IK07	IK08	IK09	IK10
Non-protected	 Protects against <1 joule impacts	 Protects against 1 joule impacts	 Protects against 2 joule impacts	 Protects against 5 joule impacts	 Protects against 10 joule impacts	 Protects against 20 joule impacts









IP RATING GUIDE

The IP Rating is a standard that classifies the level of protection provided against the intrusion of solid objects including dust, accidental contact, and water (as defined by International Standard IEC 60529).

The rating is expressed as 'IP' (Ingress Protection), followed by two numbers.

- The first digit shows the extent to which the equipment is protected against particles, or to which persons are protected from enclosed hazards
- The second digit indicates the extent of protection against water

First No.	Protection against ingress of solid objects	
X	Not tested	
0	Non-protected	
1	Protected against solid objects larger than 50mm	
2	Protected against solid objects larger than 12.5mm	
3	Protected against solid objects larger than 2.5mm	
4	Protected against solid objects larger than 1.0mm	
5	Dust-protected	
6	Dust-tight protected	

Second No.	Protection against ingress of water	
X	Not tested	
0	Non-protected	
1	Protected against vertically falling water drops	
2	Protected against vertically falling water drops when enclosure tilted up to 15°	
3	Protected against spraying water facing as a spray at any angle up to 60° from vertical	
4	Protected against splashing water from any direction	
5	Protected against water jets	
6	Protected against powerful water jets	
7	Protected against the effects of immersion between 15cm and 1m deep for 30min	
8	Protected against the effects of continuous immersion under pressure	
9	High pressure and temperature water jets	

OUTDOOR ENCLOSURES AND CABINETS OVERVIEW

	ARIA	POLYSAFE	PEDESTAL	APO	TG & GEOS SERIES	VSTX	KIOSK
Material	Polyester (GFRP)	Polyester (GFRP)	Polyester (GFRP)	Polyester (GFRP)	Polycarbonate	304 Stainless Steel	Marine Grade Aluminium
Applications	Industry, ports, petro-chemical, food & beverage, water treatment, traffic/lighting, dairy, irrigation	Industry, ports, petro-chemical, food & beverage, water treatment, traffic/lighting, dairy, irrigation	Power distribution telecommunication, traffic signalling, public lighting, marinas	Industry, ports, petro-chemical, food & beverage, water treatment, traffic/lighting, dairy, irrigation	General industry, control & automation, data, distribution, junction boxes	Food & beverage, petro-chemical, water treatment, dairy, irrigation	External Switchboards, Power distribution telecommunication, traffic signalling, marinas
Location	Indoor/Outdoor	Indoor/Outdoor	Indoor/Outdoor	Indoor/Outdoor	Indoor/Outdoor	Indoor/Outdoor	Indoor/Outdoor
UV Stabilised	High	High	High	High	High	N/A	N/A
IP Rating	IP66	IP65	IP43	IP67	IP67	IP66* *Except VSTX10830 at IP55	IP44
Impact Rating	IK10	IK10	IK10	IK10	IK07	IK10	-
Temperature Range	-50 to +70°C / continuous (150°C peak)	-50 to +70°C / continuous (150°C peak)	-50 to +125°C	-50 to +70°C / continuous (150°C peak)	-40 to +90°C	N/A	N/A
Chemical Resistance	High	High	High	High	Low	High	-
Hinged	Yes	Yes	Yes	Optional	Integrated Cover Retainer	Yes	Yes
Transparent Lid	Glazing Option	Glazing Option	N/A	Available	N/A	N/A	N/A
Colour	RAL7035	RAL7035	RAL7036	RAL7035	RAL7035	Brushed N04 Stainless	Karaka Green
Summary	A tough weatherproof cabinet for aggressive environments that can withstand outdoor exposure for a minimum of 20 years.	A tough weatherproof cabinet for aggressive environments that can withstand outdoor exposure for a minimum of 20 years. The depth of the cabinet can be increased by 320mm increments without altering the height or width.	A tough weatherproof cabinet for aggressive environments that can withstand outdoor exposure for a minimum of 20 years. Used on roadsides by Telecom and traffic signalling companies.	A tough weatherproof cabinet for aggressive environments.	Used for cable terminations electronics and multiple applications.	A tough weatherproof cabinet for aggressive environments. Specialist applications where water, chemicals or food are present.	A tough weatherproof cabinet for aggressive environments. Made of marine grade aluminium for corrosion resistance

DISCLAIMER

Vynco Industries (NZ) Limited has endeavoured to provide accurate and correct information in this publication.

Vynco Industries (NZ) Limited does not accept responsibility for any inadvertent errors or admissions contained in this catalogue, and reserves the right to change specifications and prices at any time without notice.

Please find our full Terms and Conditions of Supply of Goods and Services on our website **VYNCO.CO.NZ**

VYNCO 20 24

100% NEW ZEALAND OWNED & OPERATED

VYNCO INDUSTRIES (NZ) LIMITED

CHRISTCHURCH

388 - 396 Tuam Street, Phillipstown,
Christchurch 8011
PO Box 9022, Tower Junction,
Christchurch 8149
New Zealand
P +64 3 379 9283
E sales@vynco.co.nz

AUCKLAND

9 Levene Place, Mt Wellington,
Auckland 1060
PO Box 12 249, Penrose,
Auckland 1642
New Zealand
P +64 9 525 6051
E sales@vynco.co.nz

Stock is available for pick up from the above locations.

VYNCO.CO.NZ

